



K&SIBASIC

SIMPLE ENERGY

Inverter Generator

KSB 12i S

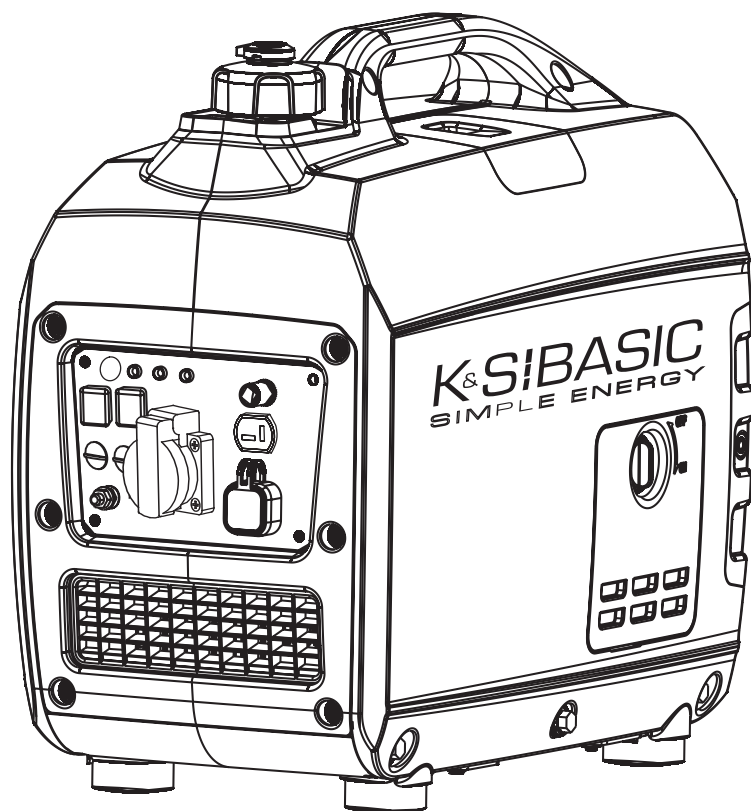



Thank you for your purchase of **K&S Basic®** products. This manual contains a brief description of safety, use and debugging. More information can be found on the official manufacturer's website in the support section: **konner-sohnen.com/manuals**

You can also go to the support section and download the full version of the manual by scanning the QR code, or on the website of the official importer of **K&S Basic®** products: **www.konner-sohnen.com**



We care about the environment, therefore, we consider it expedient to save paper and leave in print a short description of the most important sections.



Be sure to read the full version of the manual before getting started!



Manufacturer reserves the right to make alterations into the generators, which may not be reflected in this manual. Pictures and photos of the product may vary from its actual appearance. At the end of this manual, You may find contact information which you are free to use in case of any issues occurrence.

All data, specified in this operation manual is the most up to date for the moment of its publishing. The current list of service centers you can find at the website of official importer: **www.konner-sohnen.com**



ATTENTION – DANGER!



Failure to follow the recommendations marked with this sign may lead to serious injury or death of the operator or third parties.



IMPORTANT!



Useful information while operating the machine.

Safety symbols and description of inscriptions can be found in the full electronic version.

SAFETY INFORMATION

1

Do not use the generator in rooms with poor ventilation or in conditions of excessive humidity. Do not place the generator in water or on moist soil. Do not expose the generator to rain, snow, as well as to direct sunlight for a long time. Place the generator on a flat, hard surface, away from flammable liquids/gases (at a minimum distance of 1 m). Install the generator at a distance of not less than 1 m from the front control panel and not less than 50 cm on each side, including the upper part of the generator. Keep unauthorized persons, children, and animals away from work area. Wear safety shoes and gloves.



ATTENTION – DANGER!



When installing the generator, pay attention to the capacity of electrical appliances and their starting current, which may be several times higher than the rated current. The generator cannot run in overload conditions when starting consumers with an in-rush current higher than the generator's maximum output.



ATTENTION – DANGER!



Pay attention to the number of phases of the generator and the electrical system. A three-phase generator is only suitable for three-phase power consumers. Never connect a three-phase generator to a three-phase home network if there are no three-phase power consumers



ATTENTION – DANGER!



As exhaust gases contain poisonous carbon dioxide (CO₂) and carbon monoxide (CO) gases which are dangerous for life, it is strictly forbidden to install the generator in residential buildings, premises connected to residential buildings by a common ventilation system, other rooms from which exhaust gases may enter living premises.

**ATTENTION – DANGER!****The device generates electricity. Follow safety precautions to avoid electric shock.****IMPORTANT!****The generator should be used as an IT or TN system based on the application. Earthing and additional protective measures such as insulation monitoring or protection against accidental contact (residual current device) must be provided based on the application and the system used.**

The generator produces electricity that may lead to an electric shock while neglecting compliance regulations. K&S Basic generators were initially designed as an IT system with basic protection by insulation of hazardous live parts according to DIN VDE 0100-410. The generator housing is insulated from the current-carrying L and N conductors. The generator must be grounded in all cases, except for an IT system with an insulated neutral wire and bonding. A grounded IT system requires the use of an insulation monitoring device. Further details regarding the use of the generator in IT and TN systems can be found on our website or requested from our technical support. Wires with damaged or spoiled insulation should be replaced. You should also replace worn, damaged or rusty contacts.

**IMPORTANT!****It is forbidden to connect to the generator devices which can generate current pulses and direct energy towards the generator (voltage stabilizers, devices with electronic brakes, on-grid and hybrid inverters, etc.).**

The generator and power consumers form a closed system, with elements affecting each other. This system is physically different from the public network since it is significantly affected by factors such as unbalanced phase load and non-linear current consumption by power consumers that can cause damage to the generator and power consumers connected to it.

**ATTENTION – DANGER!****Be careful. Do not operate the generator, if you are tired, under the influence of drugs or alcohol. Inattention may cause a serious injury.****IMPORTANT!****Using device for other purposes deprives the right for free warranty.**

PRECAUTIONS WHEN WORKING WITH GASOLINE GENERATOR

1.2

Do not start the generator operation upon presence of electric load! Disconnect the load before you stop the engine. **Only unleaded gasoline is recommended for the generator.** It is forbidden to use kerosene or other fuel types. Before running the generator, it is necessary to define the place and means of its emergency stop. Do not refuel the running generator.

**ATTENTION – DANGER!****Fuel contaminates the land and groundwater. Do not allow the leaking gasoline from the tank!**

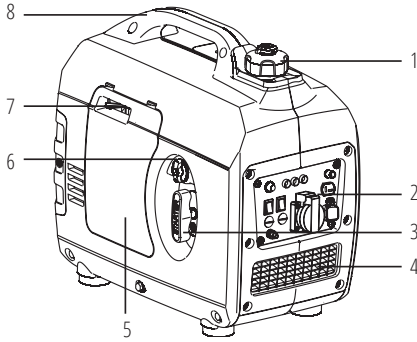

1. Fuel tank cap air vent
2. Control panel
3. Manual starter
4. Ventilation grille
5. Service cover
6. Fuel valve
7. Air choke
8. Carrying handles

1. Generator parallel socket
2. Engine start
3. Economy mode switch (ECON)
4. Reset button
5. Oil level indicator
6. Overload indicator
7. Voltage indicator
8. 12V DC fuse
9. 12V/5A DC outlet
10. 2 USB-Outputs
11. 1x16A AC outlet
12. Earthing bolt

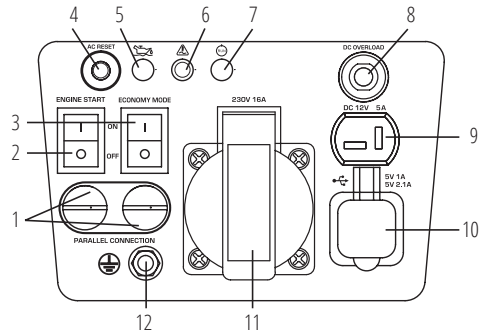

IMPORTANT!



Manufacturer reserves the right to make changes and/or improvements in design, components set and technical attributes without notice and without incurring obligation. The pictures in this manual are schematical and may not match the parameters of original product.

Model	KSB 12i S
Voltage, V	230
Max Power, kW	1.2
Nominal Power, kW	1.0
Frequency, Hz	50
Current, A (max.)	5.2
Outlets	1*16A
Engine start	manual
Fuel tank volume, l	2.5
Noise level L_{PA}(7m)/L_{WA}, dB	62/87
Output 12V, A	12V/5A
USB-Outputs	5V/1A, 5V/2.1A
Engine model	KSB 90i
Engine cylinder volume cm³	57
Crankcase volume, l	0.33
Engine type	gasoline 4 stroke cycle engine
Engine power, hp	1.8
Power factor, cos φ	1
Generator parallel socket	+
Net dimensions (LxWxH), mm	420x240x400
Net weight, kg	11.5
Protection class	IP23M
Nominal voltage tolerance – max. 5%	

*Fuel consumption depends on many factors, such as load, fuel quality, season, altitude, technical condition of the generator.

To ensure reliability and increase the engine service life, peak powers may be slightly limited by circuit breakers.

The optimal operating conditions are ambient temperature of 17-25°C, barometric pressure of 0.1 MPa (760 mm Hg), and relative humidity of 50-60%. Under these environmental conditions, the generator can provide maximum performance in terms of the declared specifications. In the event of deviations from these environmental indicators, the generator performance may vary.

Please note that in order to preserve the long service life of the generator, continuous loads of more than 80% of the nominal power are not recommended.

TERMS OF USE

4

When starting operating the generator, it's recommended to ground it. Before starting the unit, remember that the total power of consumers connected should not exceed the rated capacity of the generator.



IMPORTANT!



Make sure the control panel, louver and the inverter bottom side cooling well and without chips, mud and water come in. It may damage the engine, inverter or alternator if the cooling vent blocked.

OIL LEVEL INDICATOR

When the oil level falls below the level required for operation, the oil level indicator lights up, and then the engine stops automatically. The engine will not start until oil is added.

AC INDICATOR

When the generator is running and producing electricity, the AC indicator light is on.

OVERLOAD INDICATOR

The overload indicator lights up when the connected generator is overloaded, the inverter control unit overheats or the AC output voltage rises.

If the overload indicator goes on, the engine will continue to operate, but the generator will no longer produce electricity. In this case, you must perform the following steps:

When the overload indicator light comes on and power generation stops, proceed as follows:

1. Turn off any connected electric devices and stop the engine.
2. Reduce the total wattage of connected appliance into the rated output.
3. Check for blockages in the cooling air inlet and around the control unit. If any blockages are found, remove.
4. After checking, restart the engine.



IMPORTANT!



The overload indicator may light up within several seconds after start-up or when connecting electrical devices requiring a high starting current, such as a compressor or voltage indicator. However, this is not a malfunction.

DC PROTECTOR

The DC protector turns to "OFF" automatically when electric device being connected to the generator is operating and current above the rated flows. To use this equipment again, turn on DC protector by pressing its button to "ON".



IMPORTANT!



Reduce the load of the connected electric device below the specified rated output of the generator if the DC protector turns off. If the DC protector turns off again, stop using the device immediately and contact the point of sale and contact your nearest K&S Basic TM Service Center.

FUEL TANK CAP

Remove the fuel tank cap by turning it counterclockwise

FUEL TANK CAP AIR VENT

The fuel cap is equipped with a vent for air supply to the fuel tank. When the engine is running, the vent must be in the "ON" position (OPEN). This will allow fuel to enter the carburetor for engine operation. After the generator stops, allow it to cool down and close the air vent on the fuel cap. When the generator is not in use, close the vent to the "OFF" position.

EARTHING BOLT

In all cases, except for an IT system with an insulated neutral wire and bonding, the generator earthing bolt must be connected to the grounding circuit with a flexible copper conductor with a cross-sectional area of at least 6 mm².

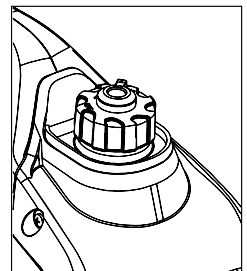

CHECK THE FUEL LEVEL

1. Unscrew the fuel cap and check the fuel level in the tank.
2. Fill the fuel tank to the fuel filter level.
3. Tighten the fuel cap securely.

**IMPORTANT!**

Immediately wipe off spilled fuel with a clean, dry, soft cloth, since fuel may deteriorate painted surfaces or plastic parts. Use only unleaded gasoline. The use of leaded gasoline will cause severe damage to internal engine parts.

Recommended fuel: Unleaded gasoline

Fuel tank volume: see specifications table.

Fig. 1

CHECK THE OIL LEVEL

Generstor is transported without the motor oil. Please don't start the engine without filling the sufficient amount of motor oil.

1. Open the service cover (Fig. 1).
2. Unscrew the oil dipstick and wipe it out with a clean cloth.
3. Fill the crankcase with engine oil. The recommended amount of oil for each model is indicated in the specification chart.
4. Insert the dipstick without screwing it in.
5. Check the oil level by a mark on the oil dipstick.
6. Add oil if its level is below the mark on the oil dipstick.
7. Screw on the dipstick.

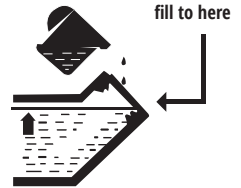

Recommended engine oil: SAE 10W-30, SAE 10W-40.

Recommended engine oil grade: API Service SE type or higher.

Motor oil quantity: see specifications table.

Before starting the engine, make sure that the rated power of power consumers matches with the power of generator. Do not exceed the nominal power of the generator. **Do not connect any devices before you start the engine!**

Do not tilt the generator when adding engine oil. This could result in over filling and damage to the engine. The generator can be used with the rated output load at standard atmospheric conditions.

**IMPORTANT!**

Do not change the controller settings in terms of the amount of fuel or speed governor (this adjustment was made at the factory). Otherwise, this may result in changes in the engine operation or its failure.

**ATTENTION - DANGER!**

In the power supply mode, the generator should operate no longer than 1 minute in the range from nominal to maximum power.

**ATTENTION - DANGER!**

Standby generators should not run continuously (e.g. by adding fuel to the tank or connecting a large fuel tank) or longer than recommended: 4-6 hours for gasoline generators (depending on load).

This material is for informational purposes only and does not constitute a manual for installing the equipment or connecting it to the mains, but we strongly recommend that you read the instructions below. Equipment connection must always be carried out by a certified electrician responsible for the installation and electrical connection of the equipment according to local laws and regulations. The manufacturer assumes no liability for improper connection of the equipment or for any material or physical damage that may result from improper installation, connection or operation of the equipment.

COMMISSIONING

1. Fill the crankcase with engine oil. The recommended amount of oil for each model is indicated in the specification chart.
2. Check oil level with an oil dipstick. It should be between the MIN and MAX marks on the oil dipstick.
3. Check fuel level.
4. Check the air filter for correct installation

IN THE FIRST 20 OPERATING HOURS OF THE GENERATOR, THE FOLLOWING REQUIREMENTS SHOULD BE MET:

1. During commissioning, do not connect power consumers, the power of which exceeds 50% of the nominal (operating) power of the device.
2. After the first 20 operating hours, be sure to change the oil. It is better to drain oil while the engine is still hot after operation to ensure quick and complete oil draining.
3. Check and clean the air filter, fuel filter and spark plug.

ENGINE START



IMPORTANT!



Useful tip: If the engine stalls or does not start, turn the engine switch to the "ON" position, and then pull the manual starter. If the oil level indicator flickers for several seconds, add oil and restart the engine.



IMPORTANT!



Each time you start the generator, be sure to check oil and fuel level



IMPORTANT!



Before starting the generator, connect the ground wire to the ground terminal.

1. Check oil level.
2. Check fuel level.
3. Open the vent on the fuel cap to the "ON" position.
4. Close the air choke.
5. Turn the fuel valve handle to the "ON" position (OPEN).
6. Set the engine switch to the "ON" position.
7. Pull the manual starter until a slight resistance is felt, then pull it toward you relatively sharply. Slowly turn the manual starter by hand, do not release it abruptly.
8. Open the air choke.
9. Allow the generator to run idle for approx. 1-2 minutes.
10. Connect the device you need to the generator outlet.

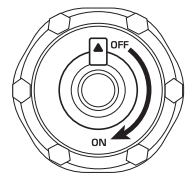
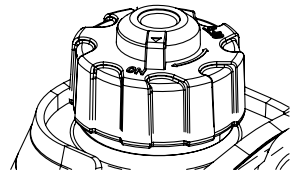

FUEL TANK VENT

The fuel tank cap is provided with a vent for sealing the fuel tank. The ventilation lever should be used; leave the ventilation lever in the "OFF" position to reduce the possibility of fuel leakage.

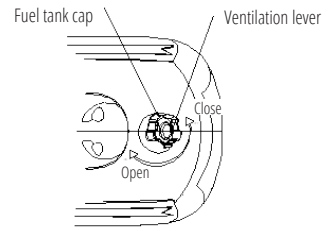

IMPORTANT!



Useful tip: to ensure long-term operation of the generator engine, it is important to observe the following tips:

- Before connecting the load, allow the engine to run for 1-2 minutes to warm it up.
- When disconnecting the load after lengthy operation, do not turn off the generator. Allow the generator to run idle for 1-2 minutes so that it cools down.

Ensure that the devices are in good condition before connecting them to the generator. If the connected device suddenly stopped working, immediately disconnect the load on the emergency stop switch, disconnect the device and check it out.

FUNCTIONAL DESCRIPTION OF INVERTER GENERATORS

8

ECON FUNCTION

1. Start the engine.
2. Set the ECON switch to "ON".
3. Plug the device into an AC outlet.
4. Make sure the AC indicator light is on.
5. Turn on the electrical device.



IMPORTANT!



The ECON switch must be set to "OFF" to increase engine speed to nominal.

"ON" MODE

When the ECON switch is in the "ON" position, the control unit monitors the engine speed, reducing it commensurate with the connected load. If the engine speed is not enough to generate electricity to provide the load, the control unit will automatically increase the engine speed.

As a result, fuel consumption is optimized and noise levels are reduced.

"OFF" MODE

The ECON switch must be set back to "OFF" when using electrical devices requiring a high starting current, such as a compressor or submersible pump.

PARALLEL FUNCTION

The total output power of the generators can be increased by connecting two inverter generators together using the Parallel Unit from Könnér & Söhnen. Parallel connection of two generators ensures total rated output power of these generators. When the generators are connected in parallel, the power loss is 0.3 kW of the total rated power that can be obtained.

DISCONNECT ALL DEVICES BEFORE STOPPING THE GENERATOR!

Do not stop the generator with the devices turned on. This may disable the generator or devices connected to it!

STOPPING THE ENGINE

To stop the engine, proceed as follows:

1. Disconnect all devices connected to the generator, then disable the ECON mode.
2. Allow the generator to run idle for approx. 1-2 minutes.
3. Turn the fuel valve to the "OFF" position.
4. Set the engine switch to the "OFF" position.
5. Turn the air choke control knob to the "OFF" position.
6. After the generator stops, allow it to cool down and close the air vent on the fuel cap (set to OFF,

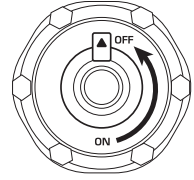
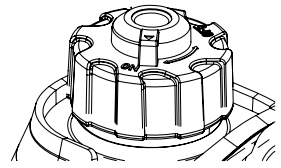

TECHNICAL MAINTENANCE WORKS

9

Works, specified in "Technical maintenance" section, are to be regularly performed. If the the generator user has no possibility to perform regular maintenance independently, it is necessary to address the official service center to registrate an order for such works performance.

You can find a list of service center addresses in your warranty card.



IMPORTANT!



MANUAL COMPLIANCE

Technical maintenance, operation and K&S Basic® generator storage are to be performed according to this manual recommendations. Manufacturer bears no responsibility for damages and losses, caused by non-compliance to safety requirements and technical maintenance rules.

TECHNICAL MAINTENANCE WORKS

Unit	Action	At each start	First month or 20 operating hours	Every 3 months or 50 operating hours	Every 6 months or 100 operating hours	Every year or 300 operating hours
Motor oil	Level check	☑				
	Replacement		☑	☑		
Air filter	Check /Cleaning	☑	☑	☑		
	Replacement				☑	
Spark plug	Cleaning		☑	☑		
	Replacement				☑	
Fuel tank	Level check	☑				
	Cleaning					☑
Fuel filter	Check (clean out)		☑	☑		

- If the generator often operates at high temperature or high load, the oil should be replaced every 25 operating hours.
- If the engine often runs in dusty or other harsh conditions, clean the air filter every 10 operating hours.
- If you missed the maintenance time, perform it as soon as possible to save the generator engine.

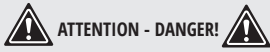

ATTENTION - DANGER!

Stop the engine before servicing. Place the generator on a flat surface and remove the spark plug cap to prevent starting the engine.

RECOMMENDED OILS

10

Motor oil has a serious impact on performance characteristics and is a major attribute, defining its service life. Use oils designed for four-stroke cycle vehicle engines, since such oils contain cleaning additives, which comply or even exceed SE standards according to API classification (or equivalent).

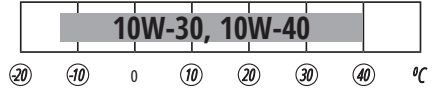

In general, the engine is recommended to run with motor oils of SAE10W-30, SAE10W-40 viscosity level. Motor oils with other viscosity levels, may be used only if the average air temperature in your region does not exceed the limits of the temperature range, specified in the table. Oil viscosity according to SAE standards or service category are specified on the API capacity sticker.

REPLACING OR ADDING MOTOR OIL:

Upon oil level decrease it is necessary to add the required quantity in order to provide the correct generator operation. It is necessary to check the oil levels according to technical maintenance schedule.

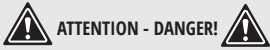
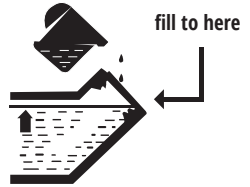

ATTENTION - DANGER!

Avoid draining the engine oil immediately after stopping the engine. The oil is hot and should be handled with care to avoid burns.

TO DRAIN OIL, PROCEED AS FOLLOWS:

1. Place the generator on a flat surface and warm up the engine for several minutes. Stop the engine and turn the fuel tank cap to the "OFF" position.
2. Remove the motor cover.
3. Place an oil drain tray under the engine.
4. Unscrew the oil drain cap with a hexagon key.
5. Wait for the oil to drain. Tilt the generator for a better result.
6. Add motor oil to a high level.
7. Wipe the oil drain cap with a clean, dry cloth and wipe off any oil spills, if any. Make sure that no dirt, dust, etc. are caught in the crankcase.
8. Replace the cap.



ATTENTION - DANGER!

Do not tilt the generator while adding oil to the engine. This can lead to overfilling and damage to the engine.

AIR FILTER TECHNICAL MAINTENANCE

11

Air filter cleaning is to be performed each 50 hours of the generator operation (every 10 hours in unusually dusty conditions).

CLEANING THE FILTER:

1. Open the clips on the upper cap of the air filter.
2. Remove the sponge filtering element.
3. Remove all dirt deposits inside the hollow case of the air filter.
4. Thoroughly wash the filtering element in warm soapy water.

5. Dry the sponge filter.
6. Dry filtering element is to be moistened by motor oil and excess oil is to be squeezed out.

SPARK PLUG TECHNICAL MAINTENANCE

12

Spark plug is an important element providing the correct engine operation. It has to be intact, without soot deposits and to have a correct gap.

SPARK PLUG INSPECTION:

1. Remove the cap from the spark plug.
2. Remove the spark plug by means of a corresponding spanner.
3. Examine the spark plug.
If it is shattered – it is necessary to replace it. Recommended replacement spark plugs – A5RTC.
4. Measure the gap. It has to be within range 0.6 – 0.7 mm.
5. Place the spark plug in its place by means of a spark plug spanner.
6. Replace the spark plug cap.

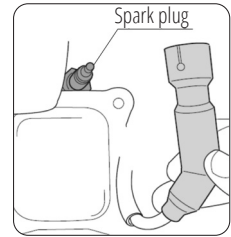
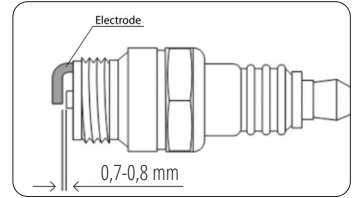

MUFFLER SCREEN AND SPARK ARRESTER TECHNICAL MAINTENANCE

13

The engine and muffler will be very hot after the engine has been run. Avoid touching the engine and muffler while they are still hot with any part of your body or clothing during inspection or repair.

1. Remove the screws, and then pull outward on the areas of the cover.
2. Loosen the bolt and remove the muffler cap, the muffler screen and spark arrester.
3. Clean the carbon deposits on the muffler screen and spark arrester using a wire brush.
4. Check the muffler screen and spark arrester. Replace them if damaged.
5. Replace the flame arrester.
6. Replace the screen and cover of the damper.
7. Replace the cover and tighten the screws.



IMPORTANT!



Tip: Align the spark arrester projection with the hole in the muffler pipe.

FUEL TANK FILTER TECHNICAL MAINTENANCE

14



ATTENTION - DANGER!



Never use the gasoline while smoking or in the vicinity of an open flame.

1. Remove the fuel tank cap and filter.
 2. Clean the filter with gasoline.
 3. Wipe the filter and install it.
 4. Install the fuel tank cap.
- Be sure the fuel tank cap is tightened securely.

The generator must be stored in a dry, well-ventilated area that is free from dust. Keep away from children and animals.



IMPORTANT!



Generator should always remain ready for operation. Therefore in case of device malfunctions, they are to be repaired before dismantling the generator for storage.

GENERATOR LONG-TERM STORAGE

If the generator will not be used for a long time, it is recommended to:

- Drain the fuel into the tank.
- Drain the motor oil.
- Pull the manual starter until a slight resistance is felt so that the inlet and drain valves get closed.
- Clean the generator from dirt and dust.

When starting the generator after long-term storage, proceed as above in the reverse order.

GENERATOR TRANSPORTATION

16

For easy generator transportation use packaging, which generator was sold in. Secure the box with the generator to avoid tipping it on the side of the carriage. Before moving the generator drain the fuel.

To move the generator from one place to another lift use transportation handles. Be careful, do not expose your feet under the generator.

GENERATOR UTILISATION

17

To prevent damage to the environment separate generator from ordinary waste and recycle them in the safest way passing a special place for disposal.

Potential faults and troubleshooting methods, as well as average device capacities can be found in the full version of the manual.

WARRANTY SERVICE TERMS

18

The international manufacturer warranty is 1 year. The warranty period starts from the date of purchase. In cases when warranty period is longer than 1 year according to local legislation please contact your local dealer. The Seller which sells the product is responsible for granting the warranty. Please contact the Seller for warranty. Within the warranty period, if the product fails because of defects in the production process, it will be exchanged on the same product or repaired.

All faults caused by the manufacturer during the warranty period will be eliminated free of charge. Warranty repair is carried out only if you have a fully completed warranty card, the Buyer's signature of acceptance of the warranty terms, as well as a document supporting the purchase (cash receipt, sales slip or invoice). In the absence thereof, as well as in the event of errors or corrections not authenticated by the seller's seal or illegible inscriptions in the warranty card or tear-off coupon, no warranty repair is carried out, no objections to quality are accepted and the warranty card is withdrawn by the service center as invalid. The device is accepted for repair clean and full.



EC Declaration of Conformity

Nr. 109

The following products have been tested by us with the listed standards and found in compliance with the European Community Machinery Directive 2006/42/EC, Electromagnetic compatibility Directive (EMC) 2014/30/EC, Noise Directive 2000/14/EC.

Manufacturer: DIMAX INTERNATIONAL GmbH
Address: Flinger Broich 203, 40235 Duesseldorf, Germany
Product: Inverter generator "K&S BASIC"
Type / Model: KSB 12i S

The statement is based on a single evaluation of above mentioned products. It does not imply an assessment of the whole production and does not permit the use of the test lab. logo. The manufacturer should ensure that all product in series production are in conformity with the product sample detailed in this report. The applicant should hold the whole technical report at disposal of the competent all the right.

Applied EC Directives: 2006/42/EC Machinery Directive
2014/30/EU Electromagnetic compatibility Directive (EMC)
2000/14/EC (+2005/88/EC) Noise Directive
(EU) 2016/1628 Non-Road mobile machinery emissions

Applied Standards: EN ISO 3744:1995
EN 55012:2007+A1: 2009
ISO 8528-13:2016
EN 60204 1:2018

Gasoline engine KSB 90i corresponds to European Emission Standard Euro V.
This is confirmed by EU TYPE-APPROVAL CERTIFICATE issued by department of transport of Madrid, Spain.
Technical service responsible for carrying out the test -IDIADA.
Date of issue 24/02/2021

2000/14/EC_2005/88/EC Annex VI

For model KSB 12i S Noise measured L_{WA} = 85 dB (A), guaranteed L_{WA} = 87 dB (A)



Issued Date: 2021-12-25
Place of issue: Duesseldorf
General director: Fomin P. *P. Fomin*

DIMAX
International
GmbH
Steuer-Nr: 103 5722 2493
UmsatzSt: DE29617274

We DIMAX INTERNATIONAL GmbH hereby declare that specified above conforms covering European Parliament and Council Directives, 2006/42/EC of 17 May 2006 Machinery Directive, Electromagnetic compatibility Directive (EMC) 2014/30/EC of 26 February 2014, Noise Directive 2000/14/EC of 8 May 2000. The CE mark above can be used under the responsibility of manufacturer. After completion of an EC declaration of Conformity and compliance with all relevant EC directives.

CONTACTS

Deutschland:

DIMAX International GmbH
Flinger Broich 203
-FortunaPark- 40235
Düsseldorf, Deutschland
koenner-soehnen.com

Ihre Bestellungen

orders@dimaxgroup.de

Kundendienst, technische Fragen und Unterstützung

support@dimaxgroup.de

Garantie, Reparatur und Service

service@dimaxgroup.de

Sonstiges

info@dimaxgroup.de

Polska:

DIMAX International
Poland Sp.z o.o.

Polen, Warczawska, 306B
05-082 Stare Babice,
info.pl@dimaxgroup.de

Україна:

ТОВ «Техно Трейд КС»,
вул. Електротехнічна 47,
02222, м. Київ, Україна
sales@ks-power.com.ua