

Please, read this manual
carefully before use!

Owner's Manual



Inverter Generator

KS 3300i
KS 4100iE
KS 4100iEG
KS 8100iEG
KS 8100iE ATSR

Inverter Generator in Soundproof Housing

KS 2000i S
KS 2000iG S
KS 4000iE S
KS 4000iEG S
KS 4000iE S ATS
KS 6000iE S
KS 6000iE S ATS

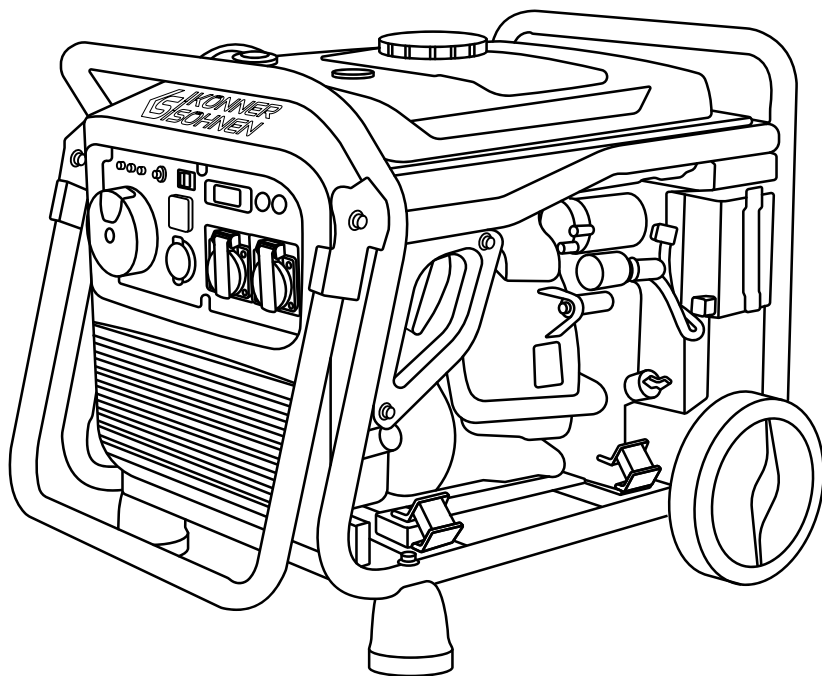



Thank you for your purchase of **Könnner & Söhnen®** products. This manual contains a brief description of safety, use and debugging. More information can be found on the official manufacturer's website in the support section: **konner-sohnen.com/manuals**

You can also go to the support section and download the full version of the manual by scanning the QR code, or on the website of the official importer of Könnner & Söhnen products: **www.konner-sohnen.com**



We care about the environment, therefore, we consider it expedient to save paper and leave in print a short description of the most important sections.



Be sure to read the full version of the manual before getting started!



Manufacturer reserves the right to make alterations into the generators, which may not be reflected in this manual. Pictures and photos of the product may vary from its actual appearance. At the end of this manual, You may find contact information which you are free to use in case of any issues occurrence.

All data, specified in this operation manual is the most up to date for the moment of its publishing. The current list of service centers you can find at the website of official importer: **www.konner-sohnen.com**



ATTENTION – DANGER!



Failure to follow the recommendations marked with this sign may lead to serious injury or death of the operator or third parties.



IMPORTANT!



Useful information while operating the machine.

SAFETY INFORMATION

1

WORKING AREA



ATTENTION – DANGER!



When installing the generator, pay attention to the capacity of electrical appliances and their starting current, which may be several times higher than the rated current. The generator cannot run in overload conditions when starting consumers with an inrush current higher than the generator's maximum output.



ATTENTION – DANGER!



Pay attention to the number of phases of the generator and the electrical system. A three-phase generator is only suitable for three-phase power consumers. Never connect a three-phase generator to a three-phase home network if there are no three-phase power consumers



ATTENTION – DANGER!



As exhaust gases contain poisonous carbon dioxide (CO₂) and carbon monoxide (CO) gases which are dangerous for life, it is strictly forbidden to install the generator in residential buildings, premises connected to residential buildings by a common ventilation system, other rooms from which exhaust gases may enter living premises.

- Do not use generator in the rain, snow and high humidity conditions, do not touch the generator with wet hands. It's prohibited to leave it in direct sunlight in summer for a long time. It is recommended to store and use the generator under a canopy or in a well ventilated area.
- Place the generator on a flat, hard surface, away from flammable liquids/gases (at a minimum distance of 1 m). Install the generator at a distance of not less than 1 m from the front control panel and not less than 50 cm on each side, including the upper part of the generator. To reduce vibration during operation and to avoid damage to the surface, where the generator is installed, it is equipped with dampers.
- Please don't use the generator near flammable gases, liquids or dust. When using the generator exhaust system gets very hot. This may cause fire or explosion of these materials.
- Be sure to follow cleanliness and good lighting in the work area. Clutter and poor lighting may cause an injury.
- Do not let the presence of unauthorized persons, children or animals when working with generator. If necessary, make sure to fencing the working area.
- Please use safety shoes and protective gloves when working with generator.

ELECTRICAL SAFETY



ATTENTION – DANGER!



The device generates electricity. Follow safety precautions to avoid electric shock.



IMPORTANT!



The generator should be used as an IT or TN system based on the application. Earthing and additional protective measures such as insulation monitoring or protection against accidental contact (residual current device) must be provided based on the application and the system used.

- The generator produces electricity that may lead to an electric shock while neglecting compliance regulations.
- Könnér & Söhnen generators were initially designed as an IT system with basic protection by insulation of hazardous live parts according to DIN VDE 0100-410. The generator housing is insulated from the current-carrying L and N conductors. The generator must be grounded in all cases, except for an IT system with an insulated neutral wire and bonding. A grounded IT system requires the use of an insulation monitoring device. Further details regarding the use of the generator in IT and TN systems can be found on our website or requested from our technical support.
- All connecting the generator to the network must be made by certified electrician in accordance with all electrical rules and regulations.
- It is not allowed to supply current from the electrical network to the generator when the power supply is restored.
- Do not allow moisture in the generator. The water inside the device increases the risk of an electric shock.
- In the high humidity level conditions generator exploit is prohibited. Keep the generator in a dry place only.
- Avoid direct contact with grounded surfaces (pipes, radiators, etc.).
- Be careful when working with power cables. Immediately replace it in case of damage, as damaged wire increases the risk of electric shock.
- Network connection should only be carried out by a qualified technician
- Connect the generator to the protective ground before operation.
- Do not connect or disconnect a generator to electricity consumers, which are placed in water on a wet or damp soil.
- Do not touch parts of the generator under voltage.
- Connect the generator to those customers only which meet the electrical characteristics and the rated power of the generator.

- Store all electrical equipment dry and clean. Wires with damaged or spoiled insulation should be replaced. You should also replace worn, damaged or rusty contacts.



IMPORTANT!



It is forbidden to connect to the generator devices which can generate current pulses and direct energy towards the generator (voltage stabilizers, devices with electronic brakes, on-grid and hybrid inverters, etc.).

The generator and power consumers form a closed system, with elements affecting each other. This system is physically different from the public network since it is significantly affected by factors such as unbalanced phase load and non-linear current consumption by power consumers that can cause damage to the generator and power consumers connected to it.



IMPORTANT!



Using device for other purposes deprives the right for free warranty.

PERSONAL SAFETY

- Be careful. Do not operate the generator, if you are tired, under the influence of drugs or alcohol. Inattention may cause a serious injury.
- Avoid inadvertent start. Make sure to set the switch to Off when you turn off the generator.



ATTENTION – DANGER!



Non compliance to these requirements may result in generator combustion or explosion, as well as in electric wiring ignition inside the structure.

- To avoid inhaling exhaust gas, the generator does not have to work in conditions of poor ventilation. Exhaust gas contains poisonous carbon monoxide.
- Make sure no outsider objects are on the generator when it is turned on. Using device for other purposes deprives the right for free warranty. It is not allowed to sit or stand on the generator.
- Always keep a stable position and balance when starting the generator.
- Do not overload the generator, use it only for the purpose.

PRECAUTIONS WHEN WORKING WITH GASOLINE GENERATOR

- Do not start the generator operation upon presence of electric load. Disconnect the load before you stop the engine.
- Generator installation is to be performed at minimum 1 meter safety distance from flammable objects. All explosive and flammable materials or substances are to be kept away from the generator, for its engine produces heat during operation.
- Do not refuel the running generator.
- It is forbidden to smoke during generator refuelling operations.
- Only unleaded gasoline is recommended for the generator. After filling the tank, all excessive fuel spillage are to be removed from the surface. It is forbidden to use kerosene or other fuel types.
- Observe the fuel tank refilling. Do not allow overfilling.
- It is forbidden to touch the exhaust system during the generator start and in process of its running.
- It is forbidden to run the generator in cases when its exposure to rain, snow and possibility of soakage exist.
- Before running the generator, it is necessary to define the place and means of its emergency stop.



ATTENTION – DANGER!



Fuel contaminates the land and groundwater. Do not allow the leaking gasoline from the tank!

PRECAUTIONS WHEN WORKING WITH HYBRID GENERATOR



IMPORTANT!



For dual fuel models, only propane-butane mixture for cars (LPG) can be used as gas! It is forbidden to use any other gas!

Do not start the generator operation upon presence of electric load! Disconnect the load before you stop the engine.

- You are allowed to connect all the power consuming supplies only after generator got warmed up. If you start generator with appliances being connected the engine may work unstable due to the fuel remains in the carburetor.

- Disconnect the load before you stop the engine, disconnect all the connected devices first, then close the gas valve, then turn off the engine. After that set the starter switch to OFF position and turn off the gas supply valve.

- Before usage make sure, that all the hoses are connected properly.

- In case of gas leakage, stop the gas flow from the source to generator and switch off all the electric appliances connected as soon as possible.

- For stopping gas powered engine: disconnect all the connected devices first, then close the gas valve, then turn off the engine. After that set the starter switch to OFF position and turn off the gas supply valve.



ATTENTION - DANGER!



Do not allow sparks near gas powered generator during its work



ATTENTION - DANGER!



The gas cylinder valve must not be closed when the generator is not running. The generator must not be operated on gas in basements.



ATTENTION - DANGER!



Pay attention! Usage of gasoline together with liquefied gas is forbidden! When you operate using gasoline, you must stop LPG supply. When you operate generator using LPG - you must stop gasoline supply.

MODEL KS 3300i

1. Manual starter
2. Frame
3. Fuel tank cap
4. Control panel
5. Oil-depth gage

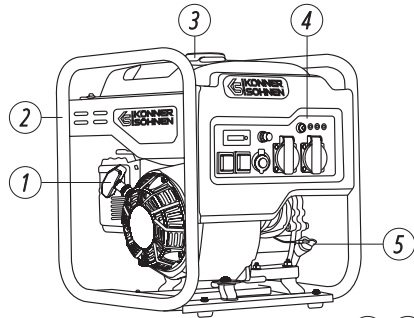

1. LED display
2. 12V DC fuse
3. Reset button
4. Oil level indicator
5. Voltage indicator
6. Overload indicator
7. Earthing bolt
8. 2x16A AC outlets
9. 12V/8.3A DC outlet
10. Economy mode switch (ECON)
11. Engine switch

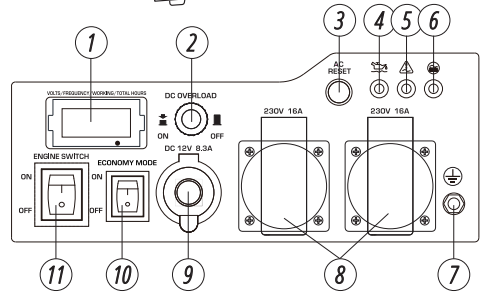

MODELS KS 4100iE, KS 4100iEG, KS 8100iEG, KS 8100iE ATSR

1. Fuel tank cap
2. Fuel level indicator
3. Control panel
4. Carrying handles
5. Manual starter (only for models KS 4100iE, KS 4100iEG)
6. Transport wheels
7. Oil-depth gage

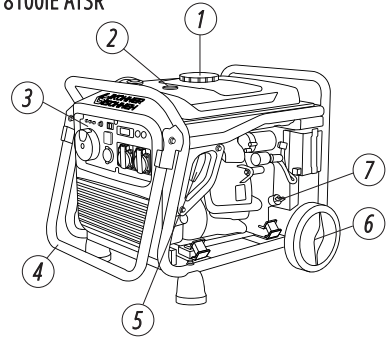

1. Multifunctional engine switch
2. Oil level indicator
3. Overload indicator
4. Voltage indicator
5. Fuel indicator (for DUAL-FUEL models)
6. Reset button
7. 12V DC fuse
8. Economy mode switch (ECON)
9. LED display
10. Generator parallel socket (except for KS 8100 model modifications)
11. Earthing bolt
12. 2x16A AC outlets (for KS 8100 model modifications, sockets 1*16A, 1*32A)
13. 12V/8.3A DC outlet
14. 2 USB-Outputs
15. Model KS 8100iE ATSR use a control panel with an ATS (Automatic Transfer Switch) output.

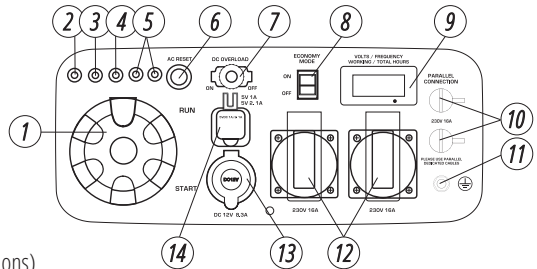

MODELS KS 2000i S, KS 2000iG S

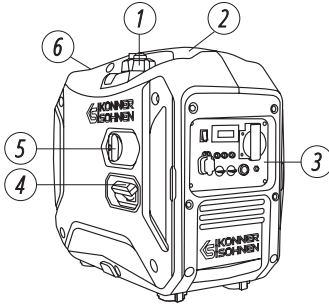

1. Fuel tank cap air vent
2. Carrying handles
3. Control panel
4. Manual starter
5. Air choke (for model KS 2000i S). Fuel switch for model KS 2000iG S. Model KS 2000iG S has an air choke located on its control panel.
6. Maintenance cover (on the other side of the generator)

1. 2 USB-Outputs (for model KS 2000i S)
2. Economy mode switch (ECON)
3. LED display
4. 1x16A AC outlet
5. Earthing bolt
6. Reset button
7. Generator parallel socket
8. For KS 2000iG S, the control panel has an air choke and a fuel switch. Use the start button instead of the multifunction engine switch.

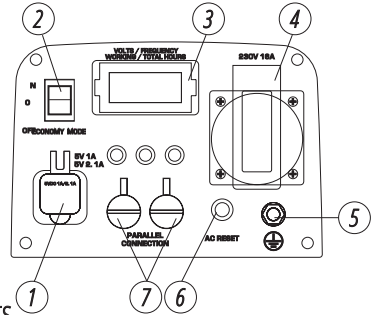

MODELS KS 4000iE S, KS 4000iEG S, KS 4000iE S ATS

1. Fuel tank cap
2. Carrying handles
3. Control panel
4. Manual starter
5. Transport wheels
6. Maintenance cover
7. Engine switch (multifunction engine switch for model KS 4000iEG S)

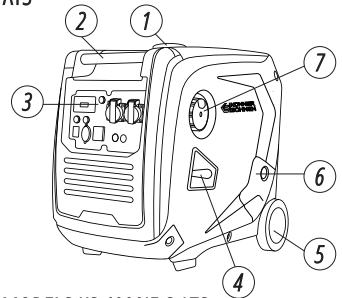

MODELS KS 4000iE S, KS 4000iEG S

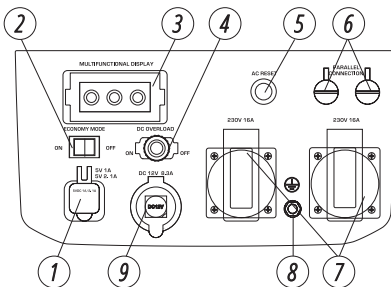

1. 2 USB-Outputs (for model KS 4000iEG S)
2. Economy mode switch (ECON)
3. LED display (multifunctional LED display for model KS 4000iE S)
4. 12V DC fuse
5. Reset button
6. Generator parallel socket
7. 2x16A AC outlets

MODELS KS 4000iE S ATS

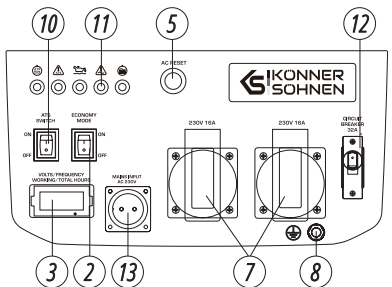

8. Earthing bolt
9. 12V/8A DC outlet
10. ATS input button
11. Oil level indicator, overload indicator, voltage indicator, ATS operation indicator, ATS operation errors
12. Circuit breaker
13. Mains input AC 230V

MODELS KS 6000iE S, KS 6000iE S ATS

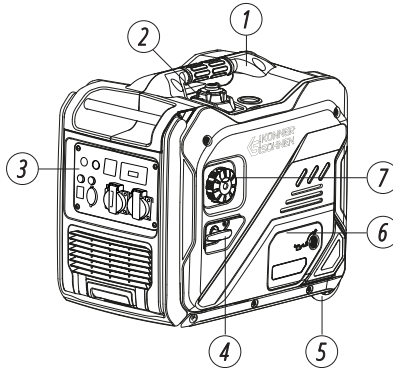

1. Carrying handle
2. Fuel tank cap air vent
3. Control panel
4. Manual starter
5. Transport wheels
6. Maintenance cover
7. Multifunction engine switch

MODELS KS 6000iE S

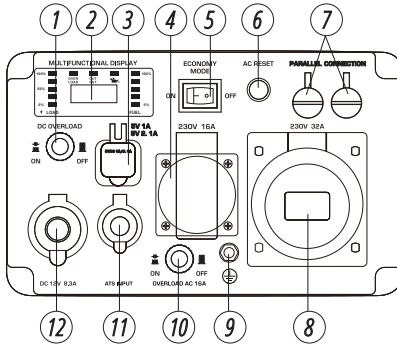

1. 12V DC fuse
2. Multifunctional LED display
3. 2 USB-Outputs
4. 1x16A AC outlet
5. Economy mode switch (ECON)
6. Reset button
7. Generator parallel socket
8. 1x32A AC outlet
9. Earthing bolt

MODELS KS 6000iE S ATS

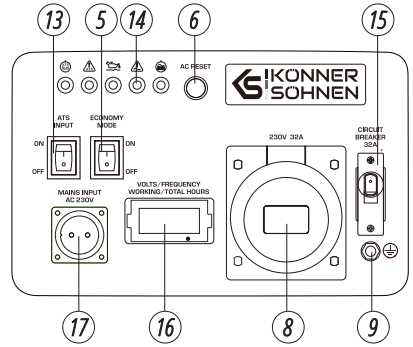

5. Oil level indicator, overload indicator, voltage indicator, ATS operation indicator, ATS operation errors
6. Reset button
7. Generator parallel socket
8. 230V 32A AC outlet
9. Circuit breaker 32A
10. 16V AC fuse
11. ATS input
12. 12V/8.3A DC outlet
13. ATS input button
14. LED display
15. Mains input AC 230V
16. Volts/Frequency Working/Total Hours meter



IMPORTANT!



Manufacturer reserves the right to make changes and/or improvements in design, components set and technical attributes without notice and without incurring obligation. The pictures in this manual are schematical and may not match the parameters of original product.

1. Generator
2. Packaging
3. Operating instructions
4. Key candle
5. Screw-driver PH2 6,0 mm
6. Case for accessories



In addition to the components shown in the figure of a gasoline generator, a generator with a hybrid system (LPG/ gasoline) is equipped with a hose for supplying LPG to the generator.

1. Built-in reducer.
2. Gas cylinder connection hose (1.5 m).

Connect the LPG hose to the LPG input



for model KS 2000iG S

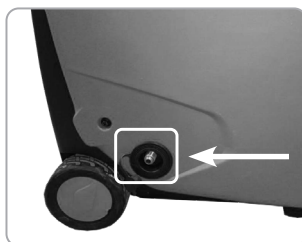

for model KS 4000iEG S

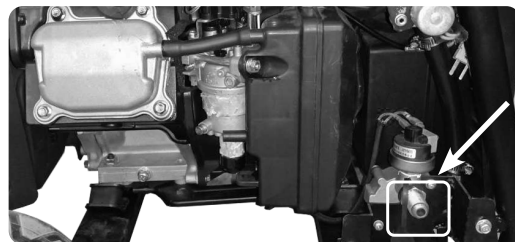

for models KS 4100iEG, KS 8100iEG

Model	KS 2000i S	KS 2000iG S
Voltage, V	230	
Maximum power, kW	2.0	2.0*
Nominal power, kW	1.8	1.8*
Frequency, Hz	50	
Current, A (max.)	8.7	8.7
Outlets	1*16A	1*16A
Engine start	manual	manual
Fuel tank volume, l	5	5
Working time at 50% load (gasoline fuel)**, h	6.25	6.25
LED display	voltage, frequency, working hours	
Noise level Lpa (7m)/Lwa, dB	62/87	62/87
Output 12V, A	-	-
USB-Outputs	5V/1A, 5V/2.1A	-
Engine model	KS 100i	KS 100i
Engine volume, cm ³	79.7	79.7
Engine type	gasoline, 4 stroke cycle engine	LPG/gasoline 4 stroke cycle engine
Engine power, hp	2.5	2.5
Generator parallel socket	+	+
Crankcase volume, l	0,4	0,4
Power factor, cos φ	1	1
ATS input	-	-
Dimensions (LxWxH), mm	555x335x540	700x335x540
Lithium battery, Ah	-	-
Net weight, kg	19	19
Protection class	IP23M	
Nominal voltage tolerance – max. 5%		

*LPG operation reduces generator power by 10%.

**Fuel consumption depends on many factors, such as load, fuel quality, season, altitude, technical condition of the generator.

To ensure reliability and increase the engine service life, peak powers may be slightly limited by circuit breakers.

The optimal operating conditions are ambient temperature of 17-25°C, barometric pressure of 0.1 MPa (760 mm Hg), and relative humidity of 50-60%. Under these environmental conditions, the generator can provide maximum performance in terms of the declared specifications.

In the event of deviations from these environmental indicators, the generator performance may vary.

Please note that continuous loads exceeding 80% of the generator's rated power are not recommended in order to extend its service life.

Model	KS 4000i S	KS 4000iEG S	KS 4000iE S ATS
Voltage, V	230		
Maximum power, kW	4.0	4.0*	4.0
Nominal power, kW	3.5	3.5*	3.5
Frequency, Hz	50		
Current, A (max.)	17.4	17.4	17.4
Outlets	2*16A	2*16A	2*16A
Engine start	manual/electro	manual/electro	manual/electro/auto
Fuel tank volume, l	12	12	12
Working time at 50% load (gasoline fuel)**, h	7.8	7.8	7.8
LED display	multifunctional***	voltage, frequency, working hours	
Noise level Lpa (7m)/Lwa, dB	66/91	66/91	66/91
Output 12V, A	12V/8.3A	12V/8.3A	-
USB-Outputs	-	5V/1A, 5V/2.1A	-
Engine model	KS 240i	KS 240i	KS 240i
Engine volume, cm³	223	223	223
Engine type	gasoline, 4 stroke cycle engine	LPG/gasoline 4 stroke cycle engine	gasoline, 4 stroke cycle engine
Engine power, hp	7.5	7.5	7.5
Generator parallel socket	+	+	-
Crankcase volume, l	0.6	0.6	0.6
Power factor, cos φ	1	1	1
ATS input	+	-	Built-in ATS
Dimensions (LxWxH), mm	630x475x570	775x475x570	630x475x570
Lithium battery, Ah	1.6	1.6	1.6
Net weight, kg	40	40	40
Protection class	IP23M		
Nominal voltage tolerance – max. 5%			

*LPG operation reduces generator power by 10%.

**Fuel consumption depends on many factors, such as load, fuel quality, season, altitude, technical condition of the generator.

***Multifunctional LED-display: load, fuel level, voltage, frequency, working hours; overload indicator, voltage indicator, oil level indicator.

To ensure reliability and increase the engine service life, peak powers may be slightly limited by circuit breakers.

The optimal operating conditions are ambient temperature of 17-25°C, barometric pressure of 0.1 MPa (760 mm Hg), and relative humidity of 50-60%. Under these environmental conditions, the generator can provide maximum performance in terms of the declared specifications.

In the event of deviations from these environmental indicators, the generator performance may vary.

Please note that continuous loads exceeding 80% of the generator's rated power are not recommended in order to extend its service life.

Model	KS 6000iE S	KS 6000iE S ATS
Voltage, V	230	
Maximum power, kW	5.5	5.5
Nominal power, kW	5.0	5.0
Frequency, Hz	50	
Current, A (max.)	23.9	23.9
Outlets	1*16A, 1*32A	1*32A
Engine start	manual/electro	manual/electro/auto
Fuel tank volume, l	11	11
Working time at 50% load (gasoline fuel)**, h	7	7
LED display	multifunctional***	voltage, frequency, working hours
Noise level Lpa (7m)/Lwa, dB	70/95	70/95
Output 12V, A	12V/8.3A	-
USB-Outputs	5V/1A, 5V/2.1A	-
Engine model	KS 240i	KS 240i
Engine volume, cm ³	223	223
Engine type	gasoline, 4 stroke cycle engine	gasoline, 4 stroke cycle engine
Engine power, hp	7.5	7.5
Generator parallel socket	+	-
Crankcase volume, l	0,7	0,7
Power factor, cos φ	1	1
ATS input	+	Built-in ATS
Dimensions (LxWxH), mm	640x425x600	
Lithium battery, Ah	1.6	1.6
Net weight, kg	39.5	40
Protection class	IP23M	
Nominal voltage tolerance – max. 5%		

*LPG operation reduces generator power by 10%.

**Fuel consumption depends on many factors, such as load, fuel quality, season, altitude, technical condition of the generator.

***Multifunctional LED-display: load, fuel level, voltage, frequency, working hours; overload indicator, voltage indicator, oil level indicator.

To ensure reliability and increase the engine service life, peak powers may be slightly limited by circuit breakers.

The optimal operating conditions are ambient temperature of 17-25°C, barometric pressure of 0.1 MPa (760 mm Hg), and relative humidity of 50-60%. Under these environmental conditions, the generator can provide maximum performance in terms of the declared specifications.

In the event of deviations from these environmental indicators, the generator performance may vary.

Please note that continuous loads exceeding 80% of the generator's rated power are not recommended in order to extend its service life.

Model	KS 3300i	KS 4100iE	KS 4100iEG
Voltage, V	230		
Maximum power, kW	3.3	4.0	4.0*
Nominal power, kW	3.0	3.6	3.6*
Frequency, Hz	50		
Current, A (max.)	14.4	17.4	17.4
Outlets	2*16A	2*16A	2*16A
Engine start	manual	manual/electro	manual/electro
Fuel tank volume, l	7	12.5	12.5
Working time at 50% load (gasoline fuel)**, h	7	8.1	8.1
LED display	voltage, frequency, working hours		
Noise level Lpa (7m)/Lwa, dB	71/96	70/95	70/95
Output 12V, A	12V/8.3A	-	-
USB-Outputs	-	5V/1A, 5V/2.1A	5V/1A, 5V/2.1A
Engine model	KS 210i	KS 240i	KS 240i
Engine volume, cm³	208	223	223
Engine type	gasoline, 4 stroke cycle engine		LPG/gasoline 4 stroke cycle engine
Engine power, hp	5.5	7.5	7.5
Generator parallel socket	-	-	+
Crankcase volume, l	0.6	0.6	0.6
Power factor, cos φ	1	1	1
ATS input	-	+	-
Dimensions (LxWxH), mm	450x380x460	605x420x425	685x420x430
Lithium battery, Ah	-	1.6	1.6
Net weight, kg	25.5	36.7	38
Protection class	IP23M		
Nominal voltage tolerance – max. 5%			

*LPG operation reduces generator power by 10%.

**Fuel consumption depends on many factors, such as load, fuel quality, season, altitude, technical condition of the generator.

To ensure reliability and increase the engine service life, peak powers may be slightly limited by circuit breakers.

The optimal operating conditions are ambient temperature of 17-25°C, barometric pressure of 0.1 MPa (760 mm Hg), and relative humidity of 50-60%. Under these environmental conditions, the generator can provide maximum performance in terms of the declared specifications.

In the event of deviations from these environmental indicators, the generator performance may vary.

Please note that continuous loads exceeding 80% of the generator's rated power are not recommended in order to extend its service life.

Model	KS 8100iEG	KS 8100iE ATSR
Voltage, V	230	
Maximum power, kW	8.5*	8.5
Nominal power, kW	8.0*	8.0
Frequency, Hz	50	
Current, A (max.)	36.9	36.9
Outlets	1*16A, 1*32A	1*16A, 1*32A
Engine start	электро	электро
Fuel tank volume, l	20	20
Working time at 50% load (gasoline fuel)**, h	6	6
LED display	voltage, frequency, working hours	
Noise level Lpa (7m)/Lwa, dB	70/95	70/95
Output 12V, A	12V/8.3A	12V/8.3A
USB-Outputs	5V/1A, 5V/2.1A	5V/1A, 5V/2.1A
Engine model	KS 480i	KS 480i
Engine volume, cm ³	458	458
Engine type	LPG/gasoline 4 stroke cycle engine	gasoline, 4 stroke cycle engine
Engine power, hp	16	16
Generator parallel socket	-	-
Crankcase volume, l	1.1	1.1
Power factor, cos φ	1	1
ATS input	-	+
Dimensions (LxWxH), mm	740x520x580	725x505x555
Lithium battery, Ah	1.6	1.6
Net weight, kg	68	68
Protection class	IP23M	
Nominal voltage tolerance – max. 5%		

*LPG operation reduces generator power by 10%.

**Fuel consumption depends on many factors, such as load, fuel quality, season, altitude, technical condition of the generator.

To ensure reliability and increase the engine service life, peak powers may be slightly limited by circuit breakers.

The optimal operating conditions are ambient temperature of 17-25°C, barometric pressure of 0.1 MPa (760 mm Hg), and relative humidity of 50-60%. Under these environmental conditions, the generator can provide maximum performance in terms of the declared specifications.

In the event of deviations from these environmental indicators, the generator performance may vary.

Please note that continuous loads exceeding 80% of the generator's rated power are not recommended in order to extend its service life.

TERMS OF USE OF INVERTER GENERATOR

5

It is recommended to ground the generator before operating it for the first time. Before starting the device, remember that the total power of the connected power consumers should not exceed the nominal power of the generator.



IMPORTANT!



Könnner & Söhnen generators were initially designed as an IT system with basic protection by insulation of hazardous live parts according to DIN VDE 0100-410. The generator housing is insulated from the current-carrying L and N conductors. The generator must be grounded in all cases, except for an IT system with an insulated neutral wire and bonding. A grounded IT system requires the use of an insulation monitoring device.



IMPORTANT!



Make sure that the control panel, the blinds and the underside of the inverter are well cooled and protected against the ingress of small solids, dirt, and water. Improper operation of the cooler can cause damage to the motor, inverter or alternator.

GENERATOR OPERATION

6

OIL LEVEL INDICATOR

When the oil level falls below the level required for operation, the oil level indicator lights up, and then the engine stops automatically. The engine will not start until oil is added.

AC INDICATOR

When the generator is running and producing electricity, the AC indicator light is on.

DC FUSE

The DC protector automatically switches to "OFF" when the current of the operating electrical device is higher than the rated current. To use this equipment again, turn on the DC fuse again by pressing the "ON" button.



IMPORTANT!



If the DC fuse turns off, reduce the load of the connected electrical device. If the DC protector turns off again, stop operation and contact your nearest Könnner & Söhnen service center.

OVERLOAD INDICATOR

The overload indicator lights up when the connected generator is overloaded, the inverter control unit overheats or the AC output voltage rises.

If the overload indicator goes on, the engine will continue to operate, but the generator will no longer produce electricity. In this case, you must perform the following steps:

1. Turn off all connected electrical appliances and stop the engine.
2. Reduce the total power of the connected devices until the nominal power of the generator is reached.
3. Check if the vent grid is clogged. Remove excess dirt or debris, if any.
4. After checking, start the engine.



IMPORTANT!



The overload indicator may light up within several seconds after start-up or when connecting electrical devices requiring a high starting current, such as a compressor or voltage indicator. However, this is not a malfunction.

FUEL TANK CAP AIR VENT (FOR MODEL KS 2000i S)

The fuel cap is equipped with a vent for air supply to the fuel tank. When the engine is running, the vent must be in the "ON" position (OPEN). This will allow fuel to enter the carburetor for engine operation. After the generator stops, allow it to cool down and close the air vent on the fuel cap. When the generator is not in use, close the vent to the "OFF" position.

EARTHING BOLT

In all cases, except for an IT system with an insulated neutral wire and bonding, the generator earthing bolt must be connected to the grounding circuit with a flexible copper conductor with a cross-sectional area of at least 6 mm².

CHECK BEFORE GETTING STARTED**7****CHECKING THE FUEL LEVEL**

1. Unscrew the fuel cap and check the fuel level in the tank.
2. Fill the fuel tank to the fuel filter level.
3. Tighten the fuel cap securely.
4. For silent models of inverter generator, open the air intake vent on the fuel cap.

Recommended fuel: unleaded fuel.

Fuel tank volume: see specifications table.

**IMPORTANT!**

Wipe up spilled fuel immediately with a clean, dry, soft cloth, as the fuel may harm painted surfaces or plastic parts.

**IMPORTANT!**

Use only unleaded gasoline. Using leaded gasoline can cause serious damage to the inside of the engine.

CHECKING THE OIL LEVEL

The generator is transported free of motor oil. Do not start the engine until it is filled with sufficient amount of motor oil.

1. Open the service cover (fig. 1).
2. Unscrew the oil dipstick (fig. 2) and wipe it out with a clean cloth.
3. Fill the crankcase with engine oil. The recommended amount of oil for each model is indicated in the specification chart.
4. Insert the dipstick without screwing it in.
5. Check the oil level by a mark on the oil dipstick.
6. Add oil if its level is below the mark on the oil dipstick.
7. Screw on the dipstick.

Recommended motor oil: SAE 10W30, SAE 10W40.

Recommended motor oil grade: API Service SG type or higher.

Motor oil quantity: see specifications table.



Fig. 1

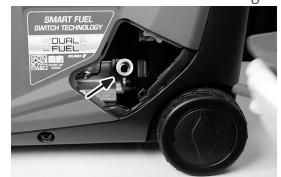

Fig. 2

GETTING STARTED**8**

Before starting the engine, make sure that the rated power of power consumers matches with the power of generator. Do not exceed the nominal power of the generator. **Do not connect any devices before you start the engine!**

**IMPORTANT!**

Do not change the controller settings in terms of the amount of fuel or speed governor (this adjustment was made at the factory). Otherwise, this may result in changes in the engine operation or its failure.



ATTENTION – DANGER!

In the power supply mode, the generator should operate no longer than 1 minute in the range from nominal to maximum power.



ATTENTION – DANGER!

Standby generators should not run continuously (e.g. by adding fuel to the tank or connecting a large fuel tank) or longer than recommended: 4-6 hours for LPG/gasoline or gasoline generators (depending on load).

This material is for informational purposes only and does not constitute a manual for installing the equipment or connecting it to the mains, but we strongly recommend that you read the instructions below. Equipment connection must always be carried out by a certified electrician responsible for the installation and electrical connection of the equipment according to local laws and regulations. The manufacturer assumes no liability for improper connection of the equipment or for any material or physical damage that may result from improper installation, connection or operation of the equipment.

COMMISSIONING

1. Fill the crankcase with engine oil. The recommended amount of oil for each model is indicated in the specification chart.
2. Check oil level with an oil dipstick. It should be between the MIN and MAX marks on the oil dipstick.
3. Check fuel level.
4. Check the air filter for correct installation.

IN THE FIRST 20 OPERATING HOURS OF THE GENERATOR, THE FOLLOWING REQUIREMENTS SHOULD BE MET:

1. During commissioning, do not connect power consumers, the power of which exceeds 50% of the nominal (operating) power of the device.
2. After the first 20 operating hours, be sure to change the oil. It is better to drain oil while the engine is still hot after operation to ensure quick and complete oil draining.
3. Check and clean the air filter, fuel filter and spark plug.



IMPORTANT!



Before starting the generator, connect the ground wire to the ground terminal.

The generator is shipped with terminals disconnected to prevent battery self-discharge during storage. To connect the battery terminals of the KS 4000iE S generator, proceed as follows:



1. Open the service cover.

ENGINE START

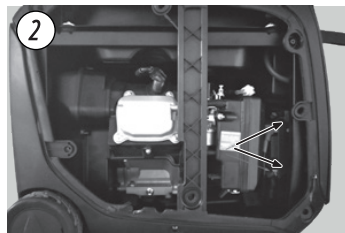

2. Connect the terminals ensuring the correct polarity (“+” to “+”, “-” to “-”).



ATTENTION!



Generator is equipped with electronics! Monitor the charge level of the battery and prevent it from being completely discharged! Generator cannot start or work correctly with a completely discharged battery, even with a recoil start.



IMPORTANT!



Useful tip: If the engine stalls or does not start, turn the engine switch to the "ON" position, and then pull the manual starter. If the oil level indicator flickers for several seconds, add oil and restart the engine.



IMPORTANT!



Each time you start the generator, be sure to check oil and fuel level

FOR MODELS KS 3300i, KS 4100iE, KS 4000iE S, KS 6000iE S, KS 8100iE ATSR, KS 6000iE S ATS

1. Check oil level.
2. Check fuel level.
3. Turn the Multifunctional engine switch to the "START" position (for Model KS 4000iE S, KS 6000iE S to the "RUN" position).
4. Open the vent on the fuel cap to the "ON" position (for model KS 6000iE S, KS 6000iE S ATS, KS 4000iE S).
- 5.1 For manual start (models KS 3300i, KS 4100iE, KS 4000iE S, KS 6000iE S, KS 6000iE S ATS), pull the manual starter until a slight resistance is felt, then pull it toward you relatively sharply. Slowly turn the manual starter by hand, do not release it abruptly.
- 5.2 For electric start, press the red button on the multifunctional engine switch (fig. 3)
6. After starting the engine, turn the Multifunctional engine switch to the "RUN" position (fig. 3).

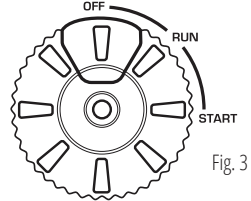

Fig. 3

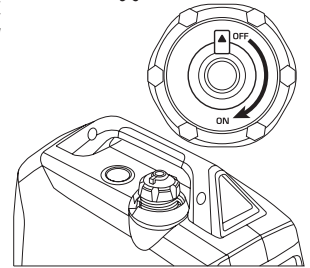

Fig. 4

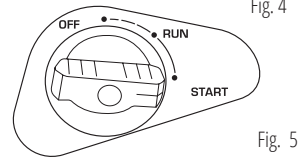

Fig. 5

FOR MODEL KS 2000i S

1. Check oil level.
2. Check fuel level.
3. Open the vent on the fuel cap to the "ON" position (fig. 4).
4. Turn the air choke control knob to the "START" position (fig. 5).
5. Pull the manual starter until a slight resistance is felt, then pull it toward you relatively sharply. Slowly turn the manual starter by hand, do not release it abruptly.
6. Turn the air choke control knob to the "RUN" position.

Useful tip: to ensure long-term operation of the generator engine, it is important to observe the following tips:

- Before connecting the load, allow the engine to run for 1-2 minutes to warm it up.
- When disconnecting the load after lengthy operation, do not turn off the generator. Allow the generator to run idle for 1-2 minutes so that it cools down.



IMPORTANT!



ATTENTION - DANGER!



Do not connect two or more devices at a time. The start-up of many devices requires high power. Devices should be connected one at a time according to their power rating. Do not connect any power consumers within the first 2 minutes after the generator has been started.

RUNNING GENERATOR ON LPG (KS 4100iEG, KS 8100iEG, KS 2000iG S, KS 4000iEG S)

1. Check oil level.
2. The inverter generators KS 4100iEG, KS 8100iEG, KS 4000iEG S use smart fuel switching system. In order to use LPG as fuel you need to connect a hose to the corresponding connector and open the valve on the gas cylinder. The solenoid valve will automatically shut off the gasoline supply from the gasoline tank.

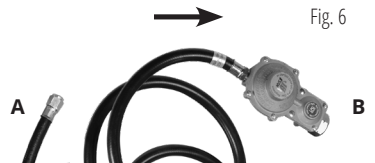

Fig. 6

3. Connect the LPG hose to the LPG input (connect hose end **A** to the LPG input, as shown in Fig. 6).
4. Connect the hose end with the reducer to the gas cylinder (connect hose end **B** to the gas cylinder, as shown in Fig. 6).
5. Open the gas valve on the cylinder, making sure that no gas is leaking.
6. Press the pressure relief valve on the reducer 2-3 times (see Fig. 6).
7. Turn the Multifunctional engine switch to the "START" position.
8. For manual start, pull the manual starter until a slight resistance is felt, then pull it toward you relatively sharply. Slowly turn the manual starter by hand, do not release it abruptly. For electric start, press the red button on the multifunctional engine switch (fig. 3)
9. After starting the engine, turn the Multifunctional engine switch to the "RUN" position (fig. 3).
10. When using for the first time, fill the gas line with gas by turning the key (pressing start button) to the "OFF" position and slowly pull the starter handle to the full cord length 2 to 3 times (except for models KS 8100, which do not have a manual start).

For model KS 2000iG S: Close the air choke (pull the air choke handle) if the generator is not warmed up. Set the GASOLINE FUEL SWITCH to the "OFF" position, set the engine start to the "ON" position, grasp the starter handle and slowly pull it until resistance is felt. Pull the starter cord to the full length with a sharp movement. The generator will start. If this is not the case, repeat this action. Slowly turn the manual starter by hand, do not release it abruptly. Open the air choke by pushing the air choke handle.



IMPORTANT!



Disconnect the load from the generator before changing fuel. The ECONOMY MODE switch must be in the "OFF" position.

For model KS 2000iG S: It is recommended to stop the generator before switching from gasoline to LPG! Gasoline remains in the carburetor make it difficult to start the engine on LPG. Let the generator run out of gasoline until it stops. To do this, close the fuel valve with the generator running and wait until the generator stops completely. Then start the generator on LPG. You can also drain the remaining gasoline from the carburetor before starting the generator on LPG.

To drain gasoline from the carburetor, turn off the fuel valve and wait until the generator has cooled down sufficiently. For open frame models, place a drip pan under the carburetor and loosen the drain screw on the carburetor (Fig. 7). Make sure that no fuel leaks onto the generator. Tighten up the screw again. Start the generator on LPG according to the instructions mentioned above

Fig. 7

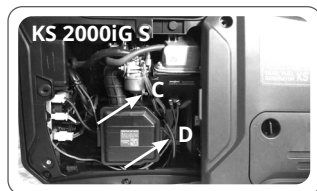

For all modifications of models KS 2000i, loosen the 4 screws on the side panel. Loosen drain screw **C** on the carburetor and let the remaining fuel drain through pipe **D** into the dedicated drip pan. Avoid gasoline leaks. Tighten up the screw. Install back the generator housing cover. Start the generator on LPG.

TO START LPG/GASOLINE GENERATOR IN GASOLINE MODE (KS 4100iEG, KS 2000iG S, KS 4000iEG S, KS 8100iEG)

1. Close the gas valve on the cylinder.
2. Open the vent on the fuel cap to the "ON"
3. Set the fuel switch to "ON" and close the air choke on the control panel (for model KS 2000iG S).
4. Start the engine by hand or electric start.
5. Open the air choke (for model KS 2000iG S).



IMPORTANT!



Place the container with gas only vertically, according to the instruction manual for gas cylinders. The horizontal placement of gas cylinders leads to hybrid generator gearbox failure.

Fuel can be changed without stopping the generator. When switching from gasoline to LPG operation, the generator may be unstable during the first 2-3 minutes and the low voltage protection may trip. If the red indicator (overload indicator) lights up in 2-3 minutes after running the generator on LPG when it is running stable, press the AC Reset BUTTON on a panel of generator to restore voltage supply

If during usage of gasoline, need to switch to LPG supply, directly connect the LPG pipe, turn on the LPG supply, and press the LPG RESET on the control panel to switch to LPG.

If during usage of LPG, need to switch to gasoline, you only need to disconnect the LPG supply, generator will automatically switch to gasoline operation, without other operations

For models with electric start, check if the battery is charged. If necessary, recharge the battery with a dedicated charger for lithium-ion batteries or start the generator with a manual start and allow it to run idle while it is recharging.

CONNECTION OF GENERATOR WITH BUILT-IN ATS

9

Connection diagrams for generators with built-in ATS can be found in the full electronic version of the manual.



ATTENTION - DANGER!



Risk of electric shock! Network connection should only be carried out by a qualified technician.

FUNCTIONAL DESCRIPTION OF INVERTER GENERATORS

10

It is forbidden to start the generator with the ECONOMY MODE ON. Economy mode should be turned on only after starting the generator and only with a low load. Failure to comply with this requirement may result in generator failure and void warranty repair.

ECON FUNCTION

1. Start the engine.
2. Set the ECON switch to "ON".
3. Plug the device into an AC outlet.
4. Make sure the AC indicator light is on.
5. Turn on the electrical device.



IMPORTANT!



The ECON switch must be set to "OFF" to increase engine speed to nominal. When connecting multiple power consumers to the generator, be sure to first connect the one with the highest starting current, and the device with the lowest starting current should be connected last.

"ON" MODE

When the ECON switch is in the "ON" position, the control unit monitors the engine speed, reducing it commensurate with the connected load. If the engine speed is not enough to generate electricity to provide the load, the control unit will automatically increase the engine speed.

As a result, fuel consumption is optimized and noise levels are reduced.

"OFF" MODE

The ECON switch must be set back to "OFF" when using electrical devices requiring a high starting current, such as a compressor or submersible pump.



IMPORTANT!



The ECON switch must be set back to "OFF" when using electrical devices requiring a high starting current, such as a compressor or submersible pump.

PARALLEL FUNCTION

The total output power of the generators can be increased by connecting two inverter generators together using the Parallel Unit KS PU1 from Könnér & Söhnen. Parallel connection of two generators ensures total rated output power of these generators. When the generators are connected in parallel, the power loss is 0.2 kW of the total rated power that can be obtained (suitable for all models of inverter generators from Könnér & Söhnen, except for KS 8100iEG, KS 8100iE ATSR).

DISCONNECT ALL DEVICES BEFORE STOPPING THE GENERATOR!

Do not stop the generator with the devices turned on. This may disable the generator or devices connected to it!

TO STOP THE ENGINE, PROCEED AS FOLLOWS (EXCEPT MODELS KS 2000i S, KS 2000iG S):

1. Turn off all devices.
2. Allow the generator to run idle for approx. 1-2 minutes.
3. Turn the Multifunctional engine switch to the "OFF" position (Fig. 9).
4. Close the gas valve
5. Unplug the devices.
6. After the generator stops, allow it to cool down and close the air vent on the fuel cap (set to OFF, as shown in Fig. 8, when switching off gasoline operation).

MODELS KS 2000i S, KS 2000iG S

1. Turn off all devices.
2. Allow the generator to run idle for approx. 1-2 minutes.
3. Set the engine switch to the "OFF" position.
4. Turn the air choke control knob to the "OFF" position (Fig. 10), for dual fuel models - move the fuel switch to the OFF position/ close LPG supply valve.
5. Allow the generator to cool down.
6. Unplug the devices.
7. After the generator stops, allow it to cool down and close the air vent on the fuel cap (set to OFF, as shown in Fig. 8, for models KS 2000i S, KS 2000iG S - when switching off gasoline operation).

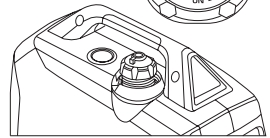
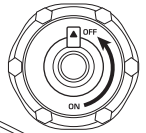

Fig. 8

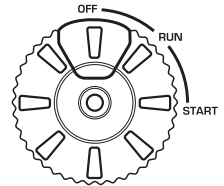

Fig. 9

CHARGING AN EXTERNAL 12 V BATTERY

1. Start the engine.
2. Connect the red wire to the positive (+) terminal of the battery.
3. Connect the black wire to the negative (-) terminal of the battery.
4. Connect the wire to a 12V/8A DC socket on the control panel of the generator.
5. To start charging the battery, set ECON to "OFF".
6. Turn the 12 V DC fuse to the "ON" position.

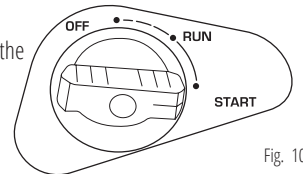

Fig. 10

**IMPORTANT!**

Inverter generators from Könnér & Söhnen are equipped with lithium batteries with an operating voltage similar to conventional lead-acid batteries. When the generator is running, the battery is charged automatically. If it is necessary to charge the battery with an external device, we recommend using the KS-B2A charger or the charger for charging lead-acid motorcycle batteries with a nominal voltage of 12V with a charge current of not more than 2A.



IMPORTANT!



- Make sure the ECON mode is off while the battery is being charged.
- Be sure to connect the charger's red wire to the plus (+) terminal of the battery and the black wire to the minus (-) terminal of the battery. Do not swap the terminals.
- Connect the charger to the battery terminals securely so that they are not disconnected due to motor vibrations or other actions.
- The 12 V socket can only be used as a backup source for recharging batteries and shall not be deemed as a full-featured battery charger.
- The DC protector turns off automatically if the current is higher than the rated current while the battery is being charged. To restore battery charging, turn on the DC fuse by pressing the "ON" button.



ATTENTION – DANGER!



Never smoke or interrupt battery connections to the generator while the battery is being charged.

MAINTENANCE

11

This manual compliance! You can find a list of service center addresses on the website of exclusive importer: www.konner-sohnen.com

TECHNICAL MAINTENANCE WORKS

Unit	Action	At each start	First month or 20 operating hours	Every 3 months or 50 operating hours	Every 6 months or 100 operating hours	Every year or 300 operating hours
Motor oil	Level check	✓				
	Replacement		✓	✓		
Air filter	Check /Cleaning	✓	✓	✓		
	Replacement				✓	
Spark plug	Cleaning		✓	✓		
	Replacement				✓	
Fuel tank	Level check	✓				
	Cleaning					✓
Fuel filter	Check (clean out)		✓	✓		

- If the generator often operates at high temperature or high load, the oil should be replaced every 25 operating hours.
- If the engine often runs in dusty or other harsh conditions, clean the air filter every 10 operating hours.
- If you missed the maintenance time, perform it as soon as possible to save the generator engine.



IMPORTANT!



The manufacturer shall not be liable for any damage caused by failure to perform maintenance work.

Use oils designed for four-stroke cycle vehicle engines SAE10W-30, SAE10W-40. Motor oils with other viscosity levels, may be used only if the average air temperature in your region does not exceed the limits of the temperature range, specified in the table.

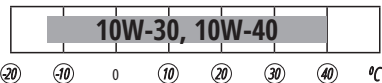

Upon oil level decrease it is necessary to add the required quantity in order to provide the correct generator operation. It is necessary to check the oil levels according to technical maintenance schedule. Further details can be found in the full version of the manual on our website.

TO DRAIN ENGINE OIL, PERFORM THE FOLLOWING ACTIONS:

1. Please drain the oil while the engine is warm. This provides a quick and complete oil drain.
2. Wear protective gloves to avoid getting oil on the skin.
3. Remove the cover of generator (fig. 11).
4. Place a drain oil holding tank under the engine (fig. 12).
5. Turn the drain cap, located in the engine under the oil-depth gage cap, by means of spanner (fig. 13).
6. Wait till the oil drains.
7. Replace the drain cap and tighten it well.
8. Close the maintenance cover (fig. 11).



Fig. 11

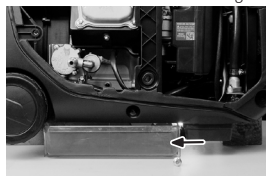

Fig. 12



Fig. 13

AIR FILTER TECHNICAL MAINTENANCE

13

Air filter cleaning is to be performed each 50 hours of the generator operation (every 10 hours in unusually dusty conditions).

CLEANING THE FILTER:

1. Open the clips on the upper cap of the air filter.
2. Remove the sponge filtering element.
3. Remove all dirt deposits inside the hollow case of the air filter.
4. Thoroughly wash the filtering element in warmsoapy water.
5. Dry the sponge filter.
6. Dry filtering element is to be moistened by motor oil and excess oil is to be squeezed out.

SPARK PLUGS TECHNICAL MAINTENANCE

14

Spark plug has to be intact, without soot deposits and to have a correct gap.

SPARK PLUG VERIFICATION:

1. Remove the cap from the spark plug.
2. Remove the spark plug by means of a corresponding spanner.
3. Examine the spark plug. If it is shattered – it is necessary to replace it.
Recommended replacement spark plugs – F7TC.
4. Measure the gap. It has to be within range 0.7-0.8 mm.

- In case of repeated use, the spark plug has to be cleaned by means of a metal brush.
After that – set the correct gap.

DAMPER AND FLAME ARRESTER MAINTENANCE

15

The engine and damper will get very hot after the generator has been started. Do not touch the engine or damper with any part of your body or clothing during inspection or repair until they have cooled down.

Remove the screws and then pull the protective cover towards you. Loosen the bolts and remove the cover, screen and flame arrester of the damper. Descal the screen and flame arrester of the damper with a wire brush. Inspect the screen and flame arrester of the damper. Replace them if they are damaged. Replace the flame arrester. Replace the screen and cover of the damper. Replace the cover and tighten the screws.



IMPORTANT!



Match the protrusion of the flame arrester to the hole in the pipe damper.

FUEL FILTER

16



IMPORTANT!



Never use gasoline while smoking or in the immediate vicinity of an open flame.

- Remove the fuel tank cap and fuel filter.
- Clean the filter with gasoline.
- Wipe the filter and replace it.
- Replace the fuel tank cap.

Make sure that the fuel tank cap is tight.

BATTERY USE

17

The generator battery is not subject to service. Low temperatures may lower the capacity of the lithium-ion battery and may cause an unstable generator start. Battery warranted – three months from the date of purchase of the generator.

STORAGE

18



IMPORTANT!



The generator must be stored and transported with a closed vent at all times!

Storage room has to be dry and free from dust deposits. Storage room also has to be locked away from children and animals. It is recommended to store and use the generator at temperature of -20°C to +40°C. Avoid direct sunlight, rain on the generator. When using and storing hybrid generator, gas tank should be kept indoors at temperatures below +10°C. If the temperature is lower, gas will evaporate.



IMPORTANT!



Warning! Generator is to remain ready for operation at all times. Therefore in case of device malfunctions, they are to be repaired before dismantling the generator for storage.



IMPORTANT!



Before long-term storage of the generator during the engine work close the fuel valve and let the engine to elaborate gasoline from carburetor. Wait until engine stops itself.

BEFORE LONG-TERM GENERATOR IDLE TIME – PERFORM THE FOLLOWING ACTIONS:

- Generator and engine external parts (especially the cooling radiators) are to be thoroughly cleaned.
- Carburetor float chamber screw has to be removed and the chamber – drained.
- Remove the spark plug.
- Oil drain screw is to be removed and the oil – drained.
- Pour one teaspoon of motor oil to the cylinder (5-10 ml). After that – pull the starter cord for a few times, to let the oil equally distribute on the cylinder walls.
- Install the spark plug.
- Pull the starter handle until you feel the resistance. to let the piston relocate to the upper pressure tact point.
- Smoothly release the starter handle.
- Remove the battery terminals. Grease the battery terminals and connecting terminals with grease to protect against oxidation.

GENERATOR TRANSPORTATION

19



IMPORTANT!



We recommend filling the fuel tank only 70% to avoid fuel spillage during generator operation and transportation.

For easy generator transportation use packaging, which generator was sold in. Secure the box with the generator so that it does not tip over during transportation. Before moving the generator drain the fuel and disconnect the terminals of the battery.

To move the generator from one place to another lift it by holding the frame. Be careful - the generators are heavy (40 to 90 kg). At least two men are needed to move the generator. Be careful, do not expose your feet under the frame of the generator.

BATTERY AND GENERATOR DISPOSAL

20

To prevent environment damage generator and battery should be separated from ordinary waste. Please recycle them in the safest way, passing it to special place for disposal.

Typical failures	Possible reason	Solution
Engine does not starting	Engine starting switch set to OFF position	Set the engine starting switch to ON
	Fuel valve set to off position	Turn the valve to ON position
	Air flap is opened	Shut the air flap
	No fuel	Add fuel
	Low-quality or dirty fuel is in engine	Change the fuel
	Sparking plug smoked or corrupted distance between contacts is not nominal	Clean or replace the plug; Set proper distance between contacts
Low engine power / heavy starting	Dirt in fuel tank	Clean the fuel tank
	Dirt in the air filter	Clean the air filter
	Water in a fuel tank/ carburetor; carburetor is jammed	Empty the fuel tank, carburetor
	Distance between contacts of a sparking plug is not nominal	Set proper distance between contacts
Engine overheated	Cooling fins are dirty	Clean the cooling fins
	Air filter is dirty	Clean the air filter
No voltage while working engine	Circuit breaker is active	Turn on the circuit breaker
	Connected cables are corrupted	Check the cables; if using extension cord, change it
	Plugged device failure	Try to connect other devices
Connected devices are not working while generator is running	Generator is overloaded	Unplug some devices to reduce load
	Short circuit occurred in one of the devices connected	Unplug that device to restore the stability of a system
	Air filter is dirty	Clean the air filter
	Repetitions of an engine are lower than nominal	Contact the service center

Device	Average power usage, W
Iron	500-1100
Air hair dryer	450-1200
Coffee machine	800-1500
Electric cooking stove	800-1800
Toaster	600-1500
Air heater	1000-2000
Vacuum cleaner	400-1000
Radio	50-250
BBQ Grill electric device	1200-2300
Oven	1000-2000
Refrigerator	100-150
TV set	100-400
Hammer drill	600-1400
Drill	400-800
Freezer	100-400
Grinding machine	300-1100
Circular saw	750-1600
Angle grinder	650-2200
Electro jigsaw	250-700
Electro planer	400-1000
Compressor	750-3000
Water pump	750-3900
Electric sawing machine	1800-4000
Electric lawn	750-3000
Electric powered engines	550-5000
Electric fan	750-1700
High pressure machine	2000-4000
Air conditioner	1000-5000

The international manufacturer warranty is 1 year. The warranty period starts from the date of purchase. In cases when warranty period is longer than 1 year according to local legislation please contact your local dealer. The Seller which sells the product is responsible for granting the warranty. Please contact the Seller for warranty. Within the warranty period, if the product fails because of defects in the production process, it will be exchanged on the same product or repaired.

All faults caused by the manufacturer during the warranty period will be eliminated free of charge. Warranty repair is carried out only if you have a fully completed warranty card, the Buyer's signature of acceptance of the warranty terms, as well as a document supporting the purchase (cash receipt, sales slip or invoice). In the absence thereof, as well as in the event of errors or corrections not authenticated by the seller's seal or illegible inscriptions in the warranty card or tear-off coupon, no warranty repair is carried out, no objections to quality are accepted and the warranty card is withdrawn by the service center as invalid. The device is accepted for repair clean and full.

WARRANTY DOES NOT COVER:

- If the user has failed to comply with the instructions in this manual.
- If the product features damaged or missing identification stickers or labels, serial numbers, etc.
- If product malfunction was due to improper transportation, storage and maintenance.
- In case of mechanical damages (cracks, chips, impact and fall marks, deformation of housing, power cord, plug or any other components), including those resulting from the freezing of water (ice formation), provided there are foreign objects inside the unit.
- If the product has been improperly installed and connected to the mains supply or misused.
- If the claimed malfunction cannot be diagnosed or demonstrated.
- If proper operation of the product can be restored following cleaning from dust and dirt, appropriate adjustment, maintenance, oil change, etc.
- If the product is used for business related purposes.
- If faults are detected, which have been caused by product overload. Signs of overload are molten or discolored parts as a result of high temperatures, damaged cylinder or piston surfaces, degraded piston rings or connecting rod bushes.
- The warranty does not cover the failure of the product automatic voltage regulator due to careless handling or mishandling.
- If faults are detected, which have been caused by instability of the user's power grid.
- If there are faults caused by contamination or fouling such as contamination of the fuel, oil or cooling system.
- If electrical cables or plugs show signs of mechanical or thermal damage.
- In the event of foreign liquids and objects, metal chips, etc. inside the product.
- If the malfunction is caused by the use of non-original spare parts and materials, oils, etc.
- If there are two or more faulty units that are not interconnected.
- If the damage was caused by natural factors such as dirt, dust, humidity, high or low temperature, natural disasters.
- In case of simultaneous failure of the rotor and stator.
- For wear parts and accessories (spark plugs, nozzles, pulleys, filter and safety elements, batteries, detachables, belts rubber seals, clutch springs, axles, hand starters, grease, mountings, working surfaces, hoses, chains, and tires).
- To preventive maintenance (cleaning, greasing, washing), installation and adjustment.
- If the product was tampered with, independently repaired or modified.
- In case of malfunctions resulting from normal wear and tear as a result of long-term use (end of life).
- If product operation was not stopped and continued after detecting a malfunction.
- Batteries supplied with equipment are covered by a warranty of three months.
- When using low-grade or inappropriate fuel.



EC Declaration of Conformity

Nr. 150

The following products have been tested by us with the listed standards and found in compliance with the European Community Machinery Directive 2006/42/EC, Electromagnetic compatibility Directive (EMC) 2014/30/EC, Noise Directive 2000/14/EC.

Manufacturer: DIMAX INTERNATIONAL GmbH
 Address: Flinger Broich 203, 40235 Duesseldorf, Germany
 Product: Inverter generators "Könner & Söhnen"
 Type / Model: KS 2000i S, KS 2000iG S, KS 3300i, KS 4000iE S, KS 4000iEG S,
 KS 4000iE S ATS, KS 4100iE, KS 4100iEG, KS 6000iE S,
 KS 6000iE S ATS, KS 8100iE ATSR, KS 8100iEG.

The statement is based on a single evaluation of above mentioned products. It does not imply an assessment of the whole production and does not permit the use of the test lab. logo. The manufacturer should ensure that all product in series production are in conformity with the product sample detailed in this report. The applicant should hold the whole technical report at disposal of the competent all the right.

Applied EC Directives: 2006/42/EC Machinery Directive
 2014/30/EU Electromagnetic compatibility Directive (EMC)
 2000/14/EC Noise Directive(amended in 2005/88/EC)
 (EU) 2016/1628 Non-Road mobile machinery emissions
 (EU)2017/654 amended by (EU) 2018/989
 (EU)2017/655 amended by (EU) 2018/987
 (EU)2017/656 amended by (EU) 2018/988

Applied Standards: EN ISO 8528-13:2016
 EN 55012:2007+A1
 EN 61000-6-1:2007
 00/14/EC
 55/88/EC

Gasoline engines KS 210i, KS 240i, KS 480i, KS 100i, correspond to European Emission Standard Stage V. This is confirmed by EU TYPE - APPROVAL CERTIFICATE issued by department of transport of Luxembourg. Technical service responsible for carrying out the test - TÜV Rheinland Luxembourg GmbH. Date of issue 30/10/2018

2000/14/EC_2005/88/EC Annex VI

For model KS 2000i S Noise measured Lwa = 87 dB (A)
 For model KS 2000iG S Noise measured Lwa = 88 dB (A)
 For models KS 4000iE S, KS 4000iE S ATS, KS 4100iE, KS 6000iE S, KS 6000iE S ATS, KS 8100iE ATSR, KS 8100iEG Noise measured Lwa = 95 dB (A)
 For models KS 3300i, KS 4000iEG S, KS 4100iE G Noise measured Lwa = 96 dB (A)

Notification body , responsible for 2006/42/EC Machinery Directive, 2014/30/EU Electromagnetic compatibility Directive (EMC) and 2000/14/EC Noise Directive certificate issuing is TÜV Rheinland LGA Products GmbH , Tillystraße 2, 90431 Nürnberg, Country: Germany, Phone: +49 (0) 9116555225, Fax: +49 (0) 9116555226, Email: service@de.tuv.com, Website: www.tuv.com/safety
Notified Body number: 0197



Issued Date:

2023-01-30

Place of issue:

Duesseldorf

General director:

Fomin P. *P. Fomin*

**DIMAX
International
GmbH**

Steuer-Nr: 103 5722 2493
USt-IdNr: DE29617274

We DIMAX INTERNATIONAL GmbH hereby declare that specified above conforms covering European Parliament and Council Directives, 2006/42/EC of 17 May 2006 Machinery Directive, Electromagnetic compatibility Directive (EMC) 2014/30/EC of 26 February 2014, Noise Directive 2000/14/EC of 8 May 2000. The CE mark above can be used under the responsibility of manufacturer. After completion of an EC declaration of Conformity and compliance with all relevant EC directives.

CONTACTS

Deutschland:

DIMAX International GmbH
Flinger Broich 203 -FortunaPark-
40235 Düsseldorf, Deutschland
www.koenner-soehnen.com

Ihre Bestellungen

orders@dimaxgroup.de

Kundendienst, technische Fragen und Unterstützung

support@dimaxgroup.de

Garantie, Reparatur und Service

service@dimaxgroup.de

Sonstiges

info@dimaxgroup.de

Polska:

DIMAX International
Poland Sp.z o.o.

Polska, Warszawska,
306B 05-082 Stare Babice,
info.pl@dimaxgroup.de

Україна:

ТОВ «Техно Трейд КС»,
вул. Електротехнічна 47, 02222,
м. Київ, Україна
sales@ks-power.com.ua
