

**Please, read this manual
carefully before use!**

Owner's Manual



Gasoline chainsaw

KS CS21G
KS CS31G

The chainsaw model KS CS21G can be equipped with a bar and chain of your choice.

The models KS CS21G-13, KS CS21G-16, KS CS21G-16-1 are modifications of the base model KS CS21G with the selected bar length and manufacturer chosen at the time of order.

The chainsaw model KS CS31G can also be equipped with a bar and chain of your choice. The models KS CS31G-16, KS CS31G-18, KS CS31G-20, KS CS31G-16-1, KS CS31G-18-1, KS CS31G-20-1 are modifications of the base model KS CS31G with the selected bar length and manufacturer chosen at the time of order.

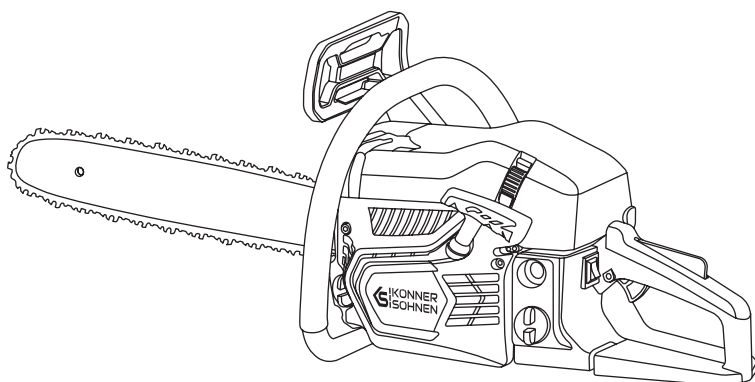



Thank you for opting for **Könnner & Söhnen®** products. This manual contains a brief description of safety, setup and use. More information can be found on the official importer's website in the support section: konner-sohnen.com/manuals

You can also go to the support section and download the manual by scanning the QR code or on the website of the official importer of **Könnner & Söhnen®** at www.konner-sohnen.com



*Please, read this manual
carefully before use!*

The manufacturer of **Könnner & Söhnen®** products reserves the right to make changes that may not be reflected in this manual, namely:

- The manufacturer reserves the right to make changes in the product design, configuration and construction.
- The images and drawings in this manual are for reference only and may differ from the actual components and inscriptions on the products.

Contact information that you are free to use in case of any problems can be found at the end of this manual. All information in this manual is correct to the best of our knowledge and belief at the date of its publication. The current list of service centers can be found on the official importer's website at www.konner-sohnen.com



ATTENTION – DANGER!



Failure to follow the recommendations marked with this sign may lead to serious injury or death of the operator or third parties.



IMPORTANT!



Useful information while operating the machine.

IMPORTANT SAFETY INFORMATION

1



WARNING!



Packaging materials are not toys! Children must not play with plastic bags! Danger of suffocation!



ATTENTION – DANGER!



Read all instructions failure to follow all instructions listed below may result in fire and /or serious injury.

WORK AREA

- Keep the work area clean and well lit. Cluttered and dark areas invite accidents.
- Do not operate tools in explosive atmospheres, such as in the presence of flammable liquids, gases or dust.
- Keep children or unauthorized individuals away from the work area, while working with tools. Distractions can cause you to lose control.

PERSONAL SAFETY

- Do not operate tool when you are tired or under the influence of drugs, alcohol or medication.
- Use safety equipment. Always wear eye protection. Safety equipment such as dust mask, non-skid safety shoes, hard hat, or hearing protection will reduce personal injuries.
- Do not overreach. Keep proper footing and balance at all times. This enables better control of the power tool in unexpected situations.

- Do not wear loose clothing or jewellery; Keep your hair, clothing and gloves away from moving parts. Loose clothes, jewellery or long hair can be caught in moving parts.
- Never start or run the chainsaw in an enclosed area. The exhaust fumes contain Carbon.

CHAIN SAW SAFETY WARNINGS

2

- Never touch the cover, guide bar, saw chain or nut with bare hands while the engine is in operation or immediately after shutting down the engine (fig. 1). Doing so could result in serious burns because of high temperature.
- Before you start the chain saw, make sure the saw chain is not contacting anything.
- Always hold the chain saw with your right hand on the rear handle and your left hand on the front handle.
- Do not operate a chain saw on a tree. Operation of a chain saw while up in a tree may result in personal injury.
- Use the tool on a level surface. Do not use it while standing on a ladder or on a slippery surface.
- Use extreme caution when cutting brush and saplings. Thin material can get into the chainsaw chain, potentially causing imbalance.
- Follow instructions for lubricating, chain tensioning and changing accessories. Improperly tensioned or lubricated chain may either break or increase the chance for kickback.
- Keep handles dry, clean, and free from oil and grease.
- Check for fuel leaks and tighten any loose fasteners.

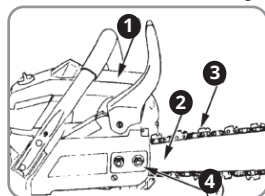

Fig. 1

- | | |
|--------------|--------------|
| 1. Cover | 3. Saw chain |
| 2. Guide bar | 4. Nut |

FUELING SAFETY

- Mix and pour fuel outdoors in areas free of sparks and flames. Use a container designed for fuel storage.
- Do not smoke or allow smoking near fuel or the chainsaw while in use.
- Wipe up all fuel spills before starting the chainsaw.
- Move 10 feet away from the fuel before starting the chainsaw.
- Stop the engine before removing the fuel tank cap.

MAINTENANCE SAFETY

- Disconnect spark plug before performing maintenance.

TRANSPORT AND STORAGE SAFETY

- Allow the engine to cool, empty the fuel tank, cover the chain with the scabbard, and secure the saw before storing or transporting in a vehicle.
- Empty the fuel tank before storing the saw. Store the saw and fuel in places where fuel vapors cannot reach sparks or open flames from appliances or electrical switches/engines.
- In case of long-term storage of the chainsaw, clean the fuel tank after emptying it. Then start the engine and empty the carburetor of fuel.

CAUSES AND OPERATOR PREVENTION OF KICKBACK

3

KICKBACK

The saw can kick back if the tip of the guide bar (especially the upper quarter) accidentally touches wood or any other hard objects. In this case, the saw will move uncontrollably (risk of injury!). Such dangerous kickbacks can largely be avoided by working quietly and with forethought in the following manner:

- While sawing, always watch the guide-bar nose
- Never attempt to cut with the nose of the guide bar.
- Take care when cutting thin and springy branches.

Particular care must be taken when inserting the into an already started cut.

- Maintain a firm grip, with both hands on the saw and position your body and arm to allow you to resist kickback forces. Kickback forces can be controlled by the operator, if proper precautions are taken.
- Do not overreach and do not cut above shoulder height. This helps prevent unintended tip contact and enables better control of the chain saw in unexpected situations.
- Only use replacement bars and chains specified by the manufacturer. Incorrect replacement bars and chains may cause chain breakage.

PULL-FORWARD

If the bumper spikes are not properly secured on the wood during sawing with the lower part of the bar, the chain may become jammed or get caught on a hard object in the wood, pulling the saw forward. To minimize these risks it is thus important to saw with the spiked stop against the timber whenever possible.

SAFETY INSTRUCTIONS

4















ATTENTION – DANGER!



Use the chain saw only to saw wood or objects made of wood!!!! Any other types of use are dangerous! The manufacturer is not liable for damage caused by improper or incorrect usage.

SAFETY INSTRUCTIONS AND ACCIDENT PREVENTION

- The saw must not be touching anything when it starts up.
- Always set the serrated stop before you start to saw.
- Do not saw with one hand.
- Do not overload your tools. They run best and safest within given range of capacity.
- Pay extra attention when cutting splintered wood. Sawed off pieces of wood may be catapulted in any direction (risk of injury!)
- Do not cut with the tip of the guide bar.
- Pay special attention to branches under tension. Do not cut through freely suspended branches from underneath.
- Always stand to the side of the tree being felled.
- When the tree is being felled, watch out for falling branches when stepping back.
- On slopes the saw operator should stand to the upper or left or right side the trunk or lying tree, never to the bottom side.
- Watch out for trunks rolling towards you.
- Always stop the engine before attempting to check or adjust the chain or to correct some fault and whenever moving from one workplace to another.
- When sawing timber that has split, take particular care that no small pieces of wood are broken off and thrown by the saw chain.
- During breaks, the saw should be laid down in such a way that there is no risk of injury to anyone from the saw chain.

| | |
|---|--|
|  | Read all safety warnings and all instructions. Failure to follow the warnings and instructions may result in fire and/or serious injury. |
|  | Wear protective equipment. Basically, wear protective goggles or, even better, face protection, ear protection, safety helmet, cut-protection working clothes, cut-protection safety boots with anti-slip soles. |
|  | CAUTION: Kickback! |
|  | Beware of falling objects. Keep bystanders away. |
|  | Do not cut with the tip of guide. |
|  | Hold the saw with both hands while working! One-handed use is extremely hazardous! |
|  | Keep the equipment away from nearby people. Keep bystanders away. |
|  | Pull to start the engine. |
|  | Push 5 to 8 times until the primer is filled with fuel. |
|  | Choke position. |
|  | Keep away from fire. |
|  | Information of the acoustic power level Lwa in dB. |

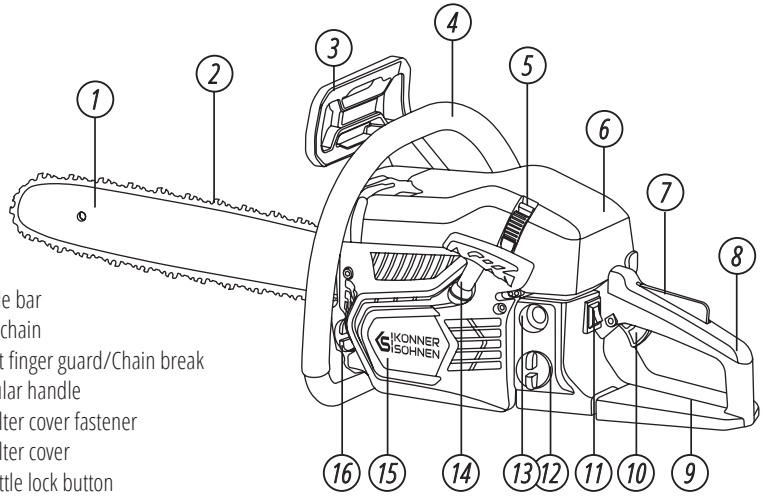

1. Guide bar
2. Saw chain
3. Front finger guard/Chain break
4. Circular handle
5. Air filter cover fastener
6. Air filter cover
7. Throttle lock button
8. Rear grip
9. Rear finger guard
10. Throttle lever
11. Switch
12. Fuel tank cover
13. Shock absorber
14. Starter handle
15. Starter
16. Oil tank cover

17. Choke lever
18. Nuts
19. Chain tension
20. Manual fuel pump

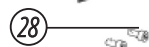
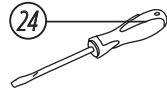
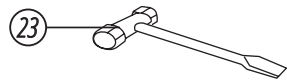
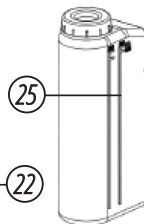
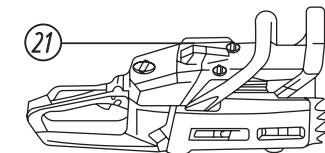
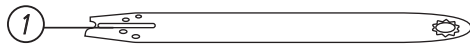
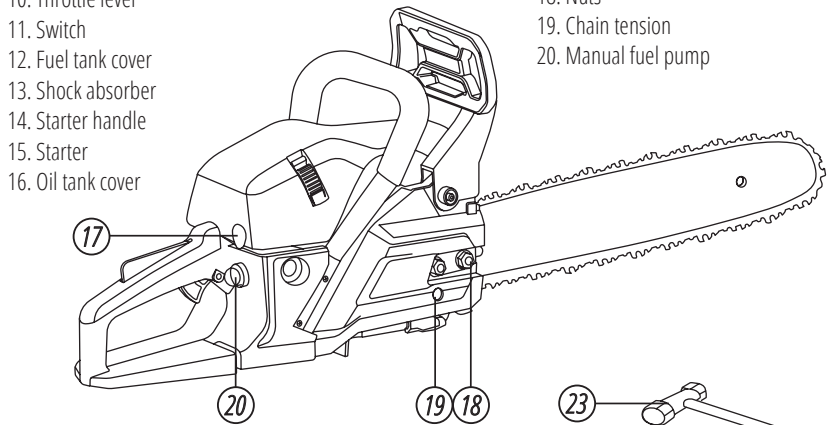

SET INCLUDES:

- | | |
|----------------------------|-------------------|
| 21. Engine | 26. Small hex key |
| 22. Guide bar cover | 27. Large hex key |
| 23. Wrench | 28. Hex bolts |
| 24. Screwdriver | 29. Round file |
| 25. Fuel mixture container | 30. Bumper spike |

**IMPORTANT!**

Manufacturer reserves the right to make changes and/or improvements in design, components set and technical attributes without notice and without incurring obligation. The pictures in this manual are schematic and may not match the parameters of original product.

SPECIFICATIONS**7**

| Model* | KS CS21G | KS CS31G |
|---|------------------------------|----------------------|
| Engine displacement | 45 cm ³ | 54,5 cm ³ |
| Maximum engine power | 1,6 kW / 8500 rpm | 2,3 kW / 8500 rpm |
| Power | 2,1 hp | 3,1 hp |
| Maximum speed | 11500±500 rpm | 11000±500 rpm |
| Idle speed | 3000±300 rpm | 3000±300 rpm |
| Carburetor | HUALONG – MC16 | WALBRO – WT-966 |
| Volume of fuel tank | 550 ml | 550 ml |
| Petrol and oil mix ratio | 40:1 | 40:1 |
| Volume of oil tank | 260 ml | 260 ml |
| Chain lubrication system | Automatic pump with adjuster | |
| Bar length (selected at the time of order) | 13"/16" | 16"/18"/20" |
| Chain pitch | 0,325" (8,25 mm) | 0,325" (8,25 mm) |
| Chain gauge | 0,058" (1,5 mm) | 0,058" (1,5 mm) |
| Noise level (Lwa) | 117 dB | 117 dB |
| Gross dimensions (L×W×H) | 430×255×300 mm | 505×255×300 mm |
| Gross/Net weight | 7,5/6,50 kg | 7,5/6,50 kg |

*The chainsaw model KS CS21G can be equipped with a bar and chain of your choice.

The models KS CS21G-13, KS CS21G-16, KS CS21G-16-1 are modifications of the base model KS CS21G with the selected bar length and manufacturer chosen at the time of order.

The chainsaw model KS CS31G can also be equipped with a bar and chain of your choice. The models KS CS31G-16, KS CS31G-18, KS CS31G-20, KS CS31G-16-1, KS CS31G-18-1, KS CS31G-20-1 are modifications of the base model KS CS31G with the selected bar length and manufacturer chosen at the time of order.

FUEL AND CHAIN OIL**8****WARNING!**

The engine should run on a mixture of gasoline and motor oil. Use only high-quality gasoline with a minimum octane rating of 95 RON.

FUEL

- Gasoline is very flammable. Avoid smoking or bringing any flame or sparks near fuel.
- Only use two-stroke engine oil designed for air-cooled engines or other high-quality oils such as JASO FB, JASO FC, JASO FD, ISO-L-EGB, ISO-L-EGC, or ISO-L-EGD classes. Never use oil for 4 cycle engine use or water cooled 2-cycle engine.
- Never use "FUEL WITH NO OIL (RAW GASOLINE)".

- Never use fuel laced with water.
- The fuel mixture ages—only mix the amount of fuel that can be used within a few weeks. Store the fuel mixture for no longer than 30 days.
- Mixed fuels which have been left unused for a period of one month or more may clog the carburetor or result in the engine failing to operate properly. Put remained fuel into an air-tight container and keep it in the dark and cool room.
- Dispose of according to the legislation in your country. Do not pour residues into the soil! Fuel contaminates groundwater!

HOW TO MIX FUEL

In a container approved for use with fuel, first pour in the motor oil, then the gasoline, and mix thoroughly.



WARNING!



RECOMMENDED FUEL TO 2-STROKE OIL RATIO 40:1

MIXING RATIO TABLE 40:1

| Amount of gasoline, L | Two-stroke engine oil, L (ml) |
|-----------------------|-------------------------------|
| 1 | 0,025 (25) |
| 2 | 0,5 (50) |
| 3 | 0,75 (75) |
| 4 | 0,10 (100) |
| 5 | 0,125 (125) |

FUELING THE UNIT

1. Choose a flat and clean surface for refueling.
2. Untwist and remove the fuel cap. Rest the cap on a dustless place.
3. Put fuel into the fuel tank to 80% of the full capacity.
4. Fasten the fuel cap securely and wipe up any fuel spillage around the unit.



NOTE



Do not use used or regenerated oil, which may cause damage to the oil pump.

CHAIN LUBRICATION

- Refill the chain lubricant every time fuel is added.

CHAIN LUBRICANTS

The service life depends to a large extent on the quality of the lubricant used. Old oil must not be used! To lubricate the cutting part of the saw, it is necessary to use only special adhesive oil for saw chains. Adhesive oil has increased adhesion to metal and lubricates not only the upper part of the saw bar but also the lower part.

TRANSPORTING THE CHAINSAW

9

- Always stop the chainsaw before transporting it, engage the chain brake, and install the chain guard.
- Transport the saw in a horizontal position, keeping the hot muffler away from yourself and the chain directed backward.
- In vehicles: Secure the chainsaw to prevent overturning, fuel and chain oil leaks, and damage.

MOUNTING THE CHAIN

10



WARNING!



The saw chain has very sharp edges. Use thick protective gloves for safety.

1. Pull the guard towards the front handle to check that the chain brake is not engaged.
2. Loosen the nuts and remove the chain cover.
3. Attach the chain brake to the engine using two screws with internal hexagon.
4. Install the guide bar onto the screws.
5. Place the cutting chain around the chain sprocket and onto the guide bar - the sharp cutting edges of the teeth should face to the right (Fig. 18). Adjust the position of chain tensioner nut on the chain cover to the lower hole of guide bar (Fig. 2)

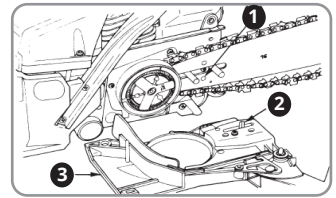

1. Hole 2. Tension pin 3. Chain cover

Fig. 3

NOTE

Pay attention to the correct direction of the saw chain (Fig. 3).

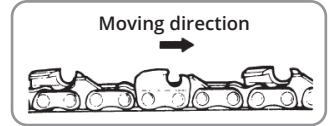
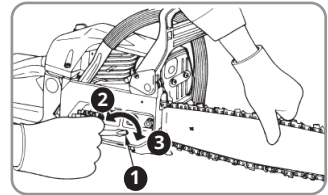

Fig. 4

6. Install the chain cover and tighten the nuts firmly by hand.
7. Supporting the tip of the bar, adjust the chain tension by turning the tensioning screw to the right until the chain touches the bottom edge of the guide bar (Fig. 4).
8. While holding the end of the guide bar raised, tighten the nuts securely. Then check the chain for smooth rotation and proper tension while moving it by hand. If necessary, readjust with the chain cover loose.



1. Tensioner screw 2. Loosen
3. Tighten

NOTE

A new chain will expand its length in the beginning of use. Check and readjust the tension frequently as a loose chain can easily derail or cause rapid wear of itself and the guide bar.

IMPORTANT!

The front finger guard must always be in the top (vertical) position.

STARTING UP A NEW SAW CHAIN

In the case of a new chain, the tensioning force decreases after some time. Therefore, you have to re-tension the chain after the first 5 cuts and no later than after 10 minutes' sawing time.

ATTENTION - DANGER!

Never attach a new chain to a worn drive pinion or place onto a damaged or worn chain bar. The chain could break, potentially leading to serious injury.

TENSIONING THE SAW CHAIN

ATTENTION - DANGER!

Before checking and adjusting the chain tension, never forget to stop the engine. Always stop the engine before doing any work on the chainsaw!

For user safety and to minimize wear or damage to the chain, regular chain tension checks are crucial. It's advisable to assess and adjust the chain tension before beginning work and then at roughly 10-minute intervals during use. Chains, particularly new ones, are prone to slight expansion when heated from use.

If the chain has been tightened while hot, loosen it after use. Failing to do so may damage the guide bar or engine due to excessive tightness as the chain cools and contracts. Both chain tension and lubrication are vital for the longevity of the chain.

A properly tensioned chain should not droop on the underside of the guide bar and should still be rotatable by hand with a glove on.



NOTE



With a new saw chain, re-tensioning is necessary after approximately five cutting operations.

CHAIN LUBRICATION

11

Lubrication is automatic. Never work without chain lubrication. Check that the oil is supplied before each use.

CHECKING THE OIL SUPPLY

12



ATTENTION – DANGER!



Make sure to set up the bar and the chain when checking the oil supply. If not, the rotating parts may be exposed. It is very dangerous.

After starting the engine, run the chain at medium speed and see if chain oil is scattered off as shown in the figure (Fig. 5).

The chain oil flow can be changed by inserting a screw-driver in the hole on bottom of the clutch side. Adjust according to your work conditions (Fig. 6).

Fig. 5

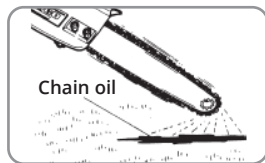
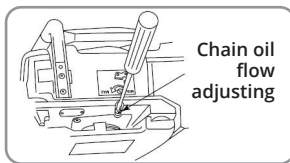

Fig. 6



OPERATING THE CHAINSAW

13

COLD ENGINE START

Before starting the engine: Place the chainsaw on the ground to attempt to start the engine, ensuring the cutting chain does not touch the ground.



ATTENTION – DANGER!



There is a risk of accidents if the chain contacts the ground during engine start-up! Components of the chainsaw could be damaged.

1. Engage the chain brake using the front hand guard. Push the front hand guard forward until it locks into place. Fill fuel and chain oil tanks respectively, and tighten the caps securely (Fig. 7).
2. The stop switch is typically in the "I" position, indicating that the ignition is on and the engine is ready to start when not pressed. If the stop switch is moved to the "0" position, the ignition is turned off. After stopping the engine, the ignition is automatically turned on again (Fig. 8).
3. Pull out the choke knob to the closed position (Fig. 9). Push 5 to 8 times until the primer is filled with fuel.



NOTE



When restarting immediately after stopping the engine, leave the choke knob at the open position.

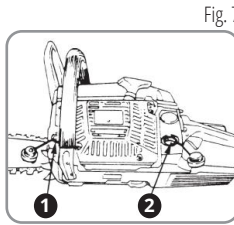

1. Chain oil 2. Fuel

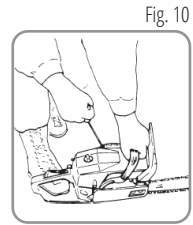
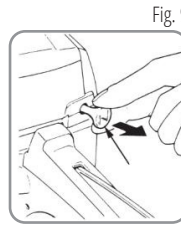
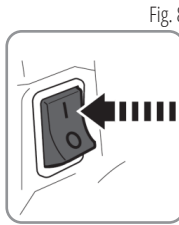

Place the chainsaw on a flat surface and secure it. To do this, place your right foot in the recess of the rear handle.

- Secure the chainsaw with your left hand on the front handle.
 - Pull the starter handle on the rope until you feel resistance, then pull quickly and forcefully. Press the tubular handle down while doing this; do not pull the rope to the end to avoid the risk of tearing! Do not allow the starter handle to snap back on its own – guide it back in an upright position so that the starter rope rewinds correctly. It may take several pulls of the starter rope until the engine starts.
4. While holding the saw unit securely on the ground, pull the starter rope vigorously (Fig. 10).
 5. When the engine first starts, turn the choke lever to the open position, then pull the starter again to start the engine.
 6. Allow the engine to warm up by gently pressing the throttle lever.



WARNING!



Keep clear of the saw chain as it will start rotating upon starting of engine.

IDLE SPEED ADJUSTMENT

The carburetor on your unit has been factory adjusted. Before adjusting the idle speed, make sure that the provided air/fuel filters are clean and fresh and the fuel properly mixed.

When adjusting, take the following steps (Fig. 11):

- Start the engine and allow it to warm up in low speed for a few minutes.
- Turn the idle adjusting screw (T) counterclockwise so that the saw chain does not turn. If the idling speed is too slow, turn the screw (T) clockwise.

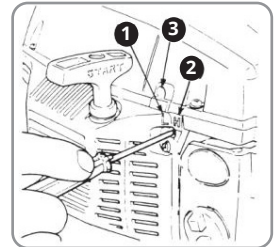

1. L needle 2. H needle
3. Idle adjusting screw (T)

CHAIN BRAKE

This machine is equipped with an automatic brake to stop saw chain upon occurrence of kickback during saw cutting. The brake is automatically operated by inertial force, which acts on the weight of the front guard (Fig. 12 a).

This brake can also be operated manually with the front guard turned down to the guide bar. To release the brake, pull up the front guard toward the front handle till a “click” sound is heard (Fig. 12 b).

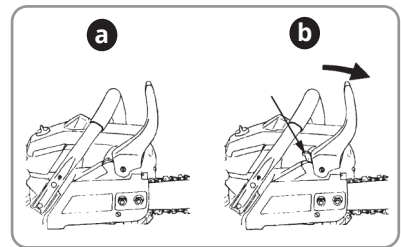

How to confirm:

During engine operation in idle mode, engage the chain brake (hand guard fully forward) and give full throttle for a short period (maximum 3 seconds) – the cutting chain should not move.

Fig. 11

Fig. 12

STOPPING THE ENGINE

Fig. 13

1. Release the throttle lever to allow the engine to idle for a few minutes.
2. Set the switch to the "O" (STOP) position (Fig. 13). If the engine stops, release the stop switch – it returns to the operating position.

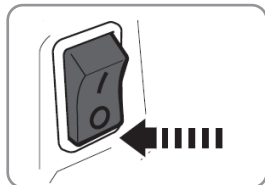

MAINTENANCE AND CLEANING GUIDELINES

14

Any service not specified in this manual should be performed by an authorized service center. Use only genuine replacement parts.

Allow the machine to cool down completely before beginning any maintenance or cleaning to avoid the risk of burns.

CLEANING PROCEDURES



ATTENTION – DANGER!



Always stop the engine before doing any work on the chainsaw!

- After each use, clean the machine thoroughly to prolong its lifespan and prevent accidents.
- Keep the handles free from oil, grease, or fuel. If necessary, wipe the handles with a damp cloth using soap, avoid using solvents or gasoline for cleaning purposes.
- Clean the saw chain after each use with a paintbrush or cloth. Do not use any liquids to clean the chain. Apply a light coating of chain oil after cleaning.
- Remove the chain wheel cover for cleaning to ensure this area is also maintained.
- Clean the chain bar (Guide).
- Use a paintbrush or dry cloth to clean the ventilation slots and machine surfaces. Refrain from using liquids for this purpose.
- Make sure to clean the oil passages of the chain bar to ensure oiling of the saw chain during operation.
- Do not modify the chain saw, otherwise your warranty will be invalid.

MAINTENANCE AFTER EACH USE

Fig. 14

1. Air filter.

Remove the 2 quick-release clamps on the filter cover using a screwdriver.

- Remove the filter cover.

Unscrew and remove the filter screw.

- Remove the filter.
- Separate the two parts of the filter using a screwdriver (Fig. 14).

- Blow out the inside of both parts of the filter with compressed air.

Check the rubber seal and replace it if necessary.

- Press the filter parts together until you hear a click, insert the filter into the housing, and securely fasten it with the filter screw.
- Reinstall the filter cover and secure it with the quick-release clamps.

2. Oiling port.

Dismount the guide bar and check the oiling port for clogging (Fig. 15).

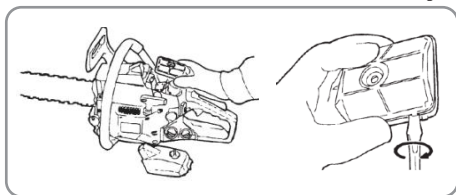
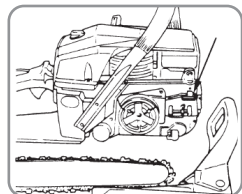

Fig. 15



3. Guide bar.

When the guide bar is dismounted, remove sawdust in the bar groove and the oiling port. Grease the nose sprocket from the feeding port on the tip of the bar (Fig. 16).

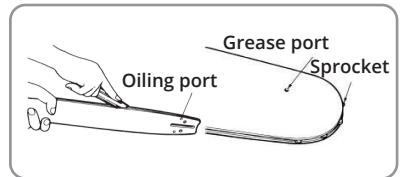

Fig. 16

4. Others.

Check for fuel leakage and loose fastenings and damage to major parts, especially handle joints and guide bar mounting. If any defects are found, make sure to have them repaired before operating the saw again.

Fig. 17

PERIODICAL SERVICE POINTS

1. Cylinder fins.

Clogging between the cylinder fins will cause overheating of the engine. Periodically check and clean the cylinder fins after removing the air cleaner and the cylinder cover. When installing the cylinder cover, make sure that switch wires and grommets are positioned correctly in place (Fig. 17).

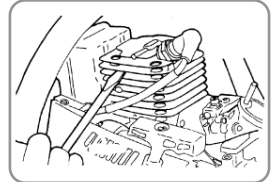

Fig. 18

Note: Be sure to block the air intake hole.

2. Fuel filter.

- Using a wire hook, take out the filter from the filler port (Fig. 18).
- Disassemble the filter and wash with gasoline, or replace with a new one if needed.

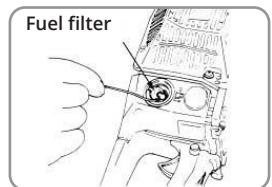

Fig. 19

Note:

- After removing the filter, use a pinch to hold the end of the suction pipe.
- When assembling the filter, take care not to allow filter fibers or dust inside the suction pipe.

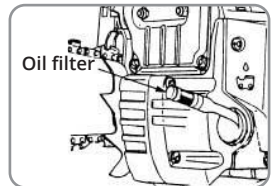

Fig. 20

3. Oil tank.

With a wire hook, take out the oil filter through the filler port and clean in gasoline. When putting the filter back into the tank, make sure that it comes to the front right corner. Also clean off dirt in the tank (Fig. 19).

4. Spark plug (Fig. 20).

Disconnect the spark plug connector.

- Unscrew the spark plug counterclockwise using a spark plug wrench. Clean the electrodes with a wire brush.
- Check the gap between the electrodes using a feeler gauge. If necessary, adjust it to 0.6–0.7 mm.
- Securely tighten the spark plug with its seal in the engine housing.

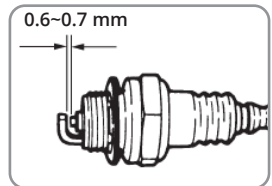

5. Sprocket (Fig. 21).

Check for cracks and for excessive wear interfering with the chain drive. If the wear is deeper than 0.5 mm, replace it with a new one. Never fit a new chain on a worn sprocket, or a worn chain on a new sprocket.

Fig. 21

6. Front and rear shock absorbers.

Replace if adhered part is peeled or crack is observed on the rubber part.

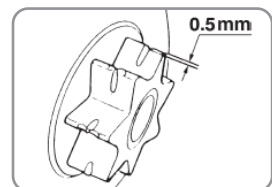

MAINTENANCE SCHEDULE

Follow a regular maintenance schedule as outlined in the following table to extend the life of your saw. Regular upkeep ensures optimal cutting performance and helps prevent accidents.

CHAINSAW MAINTENANCE SCHEDULE

| The following data applies to normal operating conditions. For challenging conditions (high dust levels, etc.) and extended daily operation, these intervals should be correspondingly reduced. For occasional use, the intervals can be increased accordingly. | | Before starting work | After each filling of the tank | After work or daily | Weekly | Monthly | Annually | In the event of a malfunction | If necessary |
|---|---|-------------------------------------|-------------------------------------|-------------------------------------|-------------------------------------|-------------------------------------|----------|-------------------------------------|-------------------------------------|
| Chainsaw overall | "Visual control (condition, tightness)" | <input checked="" type="checkbox"/> | <input checked="" type="checkbox"/> | | | | | | |
| | Cleaning | | | <input checked="" type="checkbox"/> | | | | | |
| Buttons, levers, stops, etc. | Serviceability check | <input checked="" type="checkbox"/> | <input checked="" type="checkbox"/> | | | | | | |
| Chain brake | Serviceability check | <input checked="" type="checkbox"/> | <input checked="" type="checkbox"/> | | | | | | |
| Manual fuel pump | Serviceability check | <input checked="" type="checkbox"/> | <input checked="" type="checkbox"/> | | | | | | |
| Fuel tank | Cleaning | | | | | <input checked="" type="checkbox"/> | | | |
| Fuel filter | Cleaning | | | | | <input checked="" type="checkbox"/> | | | |
| | Replacement | | | | | | | <input checked="" type="checkbox"/> | |
| Oil filter | Cleaning | | | | | <input checked="" type="checkbox"/> | | | |
| | Replacement | | | | | | | <input checked="" type="checkbox"/> | |
| Oil tank | Cleaning | | | | | <input checked="" type="checkbox"/> | | | |
| Chain lubrication | Serviceability check | <input checked="" type="checkbox"/> | | | | | | | |
| Dust chain | Check serviceability, state of sharpening | <input checked="" type="checkbox"/> | | | | | | | |
| | Check the tension | <input checked="" type="checkbox"/> | | | | | | | |
| | To sharpen | | | | | | | | <input checked="" type="checkbox"/> |
| Sprocket chain | Check for wear | | | | <input checked="" type="checkbox"/> | | | | |
| Guide rail | Check for wear and damage | <input checked="" type="checkbox"/> | | | | | | | |
| | Clean and turn over | | | <input checked="" type="checkbox"/> | | | | | <input checked="" type="checkbox"/> |
| | Remove burrs | | | | | | | | <input checked="" type="checkbox"/> |
| Air filter | Cleaning | | | <input checked="" type="checkbox"/> | | | | | |
| | Replacement | | | | | | | <input checked="" type="checkbox"/> | <input checked="" type="checkbox"/> |
| Ribs of the cylinder | Cleaning | | | | | <input checked="" type="checkbox"/> | | | <input checked="" type="checkbox"/> |
| Spark plug | Adjust the gap between the electrodes | | | | | | | <input checked="" type="checkbox"/> | |
| | Replace after every 100 engine hours | | | | | | | | <input checked="" type="checkbox"/> |
| Screws and nuts are available | Pull up | | | | | | | | <input checked="" type="checkbox"/> |
| Chain catcher | Verify | <input checked="" type="checkbox"/> | | | | | | | |
| | Replace | | | | | | | <input checked="" type="checkbox"/> | |

SHARPENING THE SAW CHAIN

15



ATTENTION – DANGER!

A properly sharpened saw chain is crucial to minimize kickback danger. A sharp chain provides efficient cutting, slicing through wood easily. A blunt chain requires a strong pressure on the saw, which may cause the engine overload.

The chain's cutting parts include a cutting tooth and a depth gauge. The vertical distance between these components defines the cutting depth. Keep in mind the following specifications when sharpening the cutting teeth:

- Top-plate cutting angle (30°)
- Side-plate angle (85°)
- Depth gauge setting (0.65 mm)

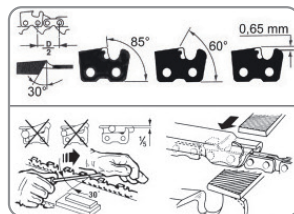

ATTENTION – DANGER!

Deviating from the specified cutting geometry increases kickback risk.

Sharpening the saw chain requires expertise and specific tools to maintain correct angles and depth. Follow the instructions for sharpening chain. For those inexperienced with chainsaw maintenance, it's advisable to have the chain sharpened or replaced by a professional.

1. Turn off the saw and saw engine.
2. Use a 4,8 mm round file for sharpening.



WARNING!

Using other diameters can damage the chain and increase operational risks!

3. Always file from the inside out, guiding the file from the inside of the tooth outward and lifting the file on the return stroke.
4. Start by sharpening the teeth on one side, then turn the saw to sharpen the other side.
5. Post-sharpening, all cutting elements should be uniform in length.
6. Every third sharpening, check and file the depth gauge to maintain the correct setting of 0.65 mm below the cutting tooth, rounding off the front edge slightly after adjustment.

GUIDE BAR AND WHEEL

16

The guide bar is subjected to especially severe wear and tear at the nose and the bottom. To avoid one-sided wear and tear, turn the guide bar over every time when you sharpen the chain. The chain wheel is subjected to especially high wear and tear as well. If you notice deep wear marks on the teeth, the chain wheel must be replaced. A worn chain wheel curtails the service life of the saw chain.

CHAIN GUARD

17

The chain guard must be clipped as soon as the sawing work has been completed and whenever the chainsaw has to be transported.

OPERATION - TIPS ON CHAIN SAW USE

18

If possible, always use a sawhorse (see Fig. M in Annex).

You have better control when you saw with the bottom side of the chain bar (with pulling saw chain) and not to with the top side of the chain bar (with pushing saw chain).

The saw chain must not contact either the ground or another object during sawing through or after sawing completion.

Make sure that the saw chain does not become jammed in the wood. Do not let the tree trunk break or split off.

Consider also the precautions against kick-back (see notes on safety).

For sawing work on hillsides, always stand in the area above the log.

To keep total control while sawing through, reduce the pressure at the end of the cut without loosening your grip on the handles of the chain saw. Make sure the saw chain does not touch the ground. After finishing the cut, wait until the chain saw comes to a halt before removing it. Always shut off the engine of the chain saw before moving between trees.

If the saw chain jams, do not attempt to pull the chainsaw out with force. There is a risk of injury. Switch off the motor and use a lever or wedge to release the chainsaw.

FELLING TREES

A lot of experience is required in felling trees. Only cut down trees when you can handle the chain saw safely.

For safety reasons, we advise inexperienced users not to knock down trunks with a guid bar smaller than the diameter of the trunk.

Ensure that no people or animals are in the field of action. The safety distance between the tree to be felled and the nearest-located workplace must be 2 ½ tree lengths.

Pay attention to the direction of fall:

The user must be able to safely move around the felled tree, easily saw the tree and remove the branches. Avoid getting the cut tree caught on another tree. Pay attention to the natural direction of fall, which depends on the characteristics of the inclination and curvature of the tree, the direction of the wind and the number of branches.

For sawing work on hillsides, the user of the chainsaw should stay in the area above the tree that is to be felled, as the tree will probably roll down or slide off downhill after being felled.

Small trees, with a diameter of 15- 18 cm, can usually be sawn off with one cut.

In case of trees with a larger diameter, a notched cut and a back cut must be implemented (see diagram).

Do not fell any trees when a strong or changing wind is blowing, if the danger of property damage exists or if the tree could fall on electric wires.

When felling trees, ensure that no other persons are exposed to hazards, that no supply lines are hit, and that no property damage is caused. If a tree should come into contact with a supply line, the utility company must be informed immediately.



WARNING!



Felling trees is dangerous and requires practice!

PREPARATION OF THE WORKING AREA NEAR THE TRUNK

1. Branch removal: remove overhanging branches. When removing branches, never work above shoulder level.

2. Escape area:

Remove the undergrowth around the tree to ensure an easy escape. The escape area (see Fig. O(1) in Annex) should be around 45° either side behind the planned felling direction (see Fig. O(2) in Annex).

3. Cutting notch (see Fig. P (a), R in Annex):

Make a felling notch in the direction in which you wish the tree to fall. Start with the bottom, horizontal cut. The cut depth should be around 1/3 of the trunk diameter. Now make a slanted saw cut from above at an angle of roughly 45° to meet exactly with the bottom saw cut.

4. Felling cut (see Fig. P (b), R in Annex):

Cut horizontally towards the felling notch. The back cut must run horizontally 5 cm above the horizontal notched cut. Leave approx. 1/10 of diameter uncut. This is the hinge.

The hinge prevents the tree from turning and falling in the wrong direction. Do not cut through the hinge.

5. If the saw begins to pinch, insert a wedge to open the cut. Use wooden, plastic or aluminium wedges to open the cut and fell the tree (see Fig. Q in Annex).

6. After carrying out of the felling cut, the tree falls by itself or with the aid of the felling wedges or fall lifter (see Fig. Q in Annex).

As soon as the tree begins to fall, pull out the saw, stop the motor, and leave the work place using the escape path (see Fig. O(1) in Annex).

Pay attention to falling branches and do not stumble.

Limbing

Many accidents occur during the removal of branches. Never cut tree limbs when you are standing on the log. Keep the spring-back area in mind if branches are under tension.

- Do not remove support branches until after the sawing off.
- Branches under tension must be sawed from below to above, in order to prevent jamming of the chainsaw (see Fig. N in Annex).
- When working on thicker branches, use the same technique as when you are sawing up a felled trunk. Work to the left of the log and as near as possible to the chainsaw. As far as possible, the weight of the saw should rest on the log.
- Change position to saw off branches on the other side of the trunk.
- Branches sticking out are cut off separately.
- Cut off smaller branches, as shown in Figure, in one go.

BUCKING

This refers to sawing up a felled tree trunk into smaller sections.

Ensure that the saw chain does not come in contact with the ground during sawing.

Make sure you have a secure stance and, in the case of sloping ground, stand above the log.

Ensure that you have secure footing and balance your body weight evenly on both feet. If possible, the trunk should be protected and supported by branches, logs or wedges. Follow the simple instructions for easy sawing.

1. Log is lying on the ground: Saw through the log completely from above and ensure at the end of the cut not to contact the ground (see Fig. J in Annex).

If you can turn the tree trunk, saw two-thirds of the way through it. Then turn the trunk around and saw the rest of the way through from above.

2. Log is supported at one end (see Fig. K in Annex):

Start sawing from the bottom and work your way up (with the upper edge of the bar) a third of the way into the diameter of the trunk to prevent splitting. Then saw from the top downwards with the lower edge of the bar towards the first cut to prevent the bar from becoming jammed in the wood.

3. The Log is support at both ends (see Fig. L in Annex):

Start from the top and work down (with the lower edge of the bar) to a third of the diameter of the trunk. Then saw from underneath with the upper edge of the bar until the two cuts meet.

REPAIR INSTRUCTIONS

19

Users of this device may only perform maintenance and care tasks described in this operating manual. Other repair work may only be carried out by specialized dealers.

DISPOSAL

20



Do not throw it in the domestic waste but dispose of it in an environmentally safe way, in accordance with current law.

- Empty the fuel tank before storing the saw.
- Store the tool in places inaccessible to children.
- Keep the tool in good working condition.
- Keep cutting tools sharp and clean. Properly maintained cutting tools with sharp cutting edges are less likely to bind and are easier to control.
- Protect it from exposure to direct sunlight. Keep it in the dark, if possible.
- Don't keep it in plastic bags to avoid humidity build-up.

The international manufacturer warranty is 1 year. The warranty period starts from the date of purchase. In cases when warranty period is longer than 1 year according to local legislation please contact your local dealer. The Seller which sells the product is responsible for granting the warranty. Please contact the Seller for warranty. Within the warranty period, if the product fails because of defects in the production process, it will be exchanged on the same product or repaired.

All faults caused by the manufacturer during the warranty period will be eliminated free of charge. Warranty repair is carried out only if you have a fully completed warranty card, the Buyer's signature of acceptance of the warranty terms, as well as a document supporting the purchase (cash receipt, sales slip or invoice). In the absence thereof, as well as in the event of errors or corrections not authenticated by the seller's seal or illegible inscriptions in the warranty card or tear-off coupon, no warranty repair is carried out, no objections to quality are accepted and the warranty card is withdrawn by the service center as invalid. The device is accepted for repair clean and full.

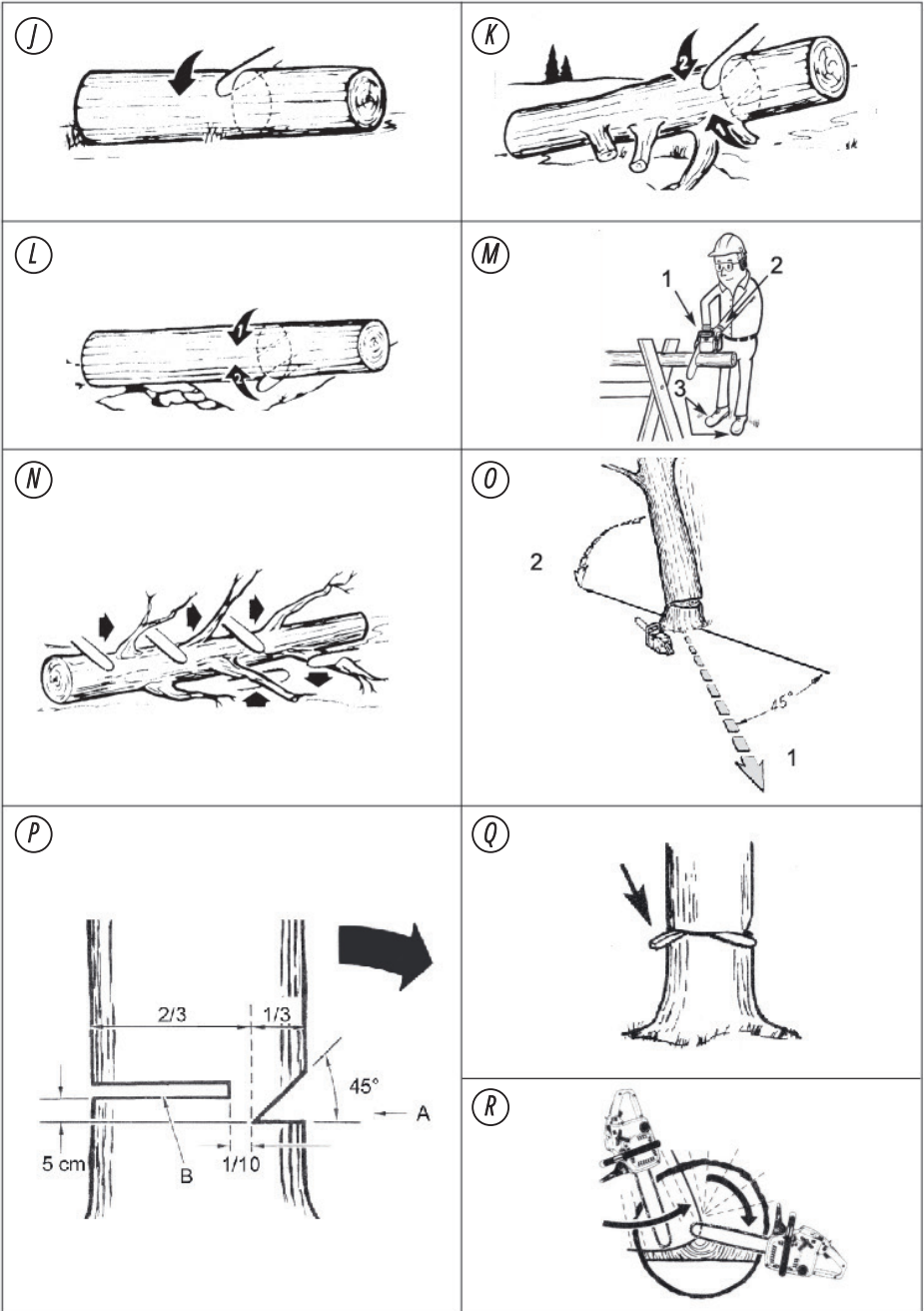



EC Declaration of Conformity

Nr. 192

The following products have been tested by us with the listed standards and found in compliance with the European Community Machinery Directive 2006/42/EC, Noise Directive 2000/14/EC.

Manufacturer: DIMAX INTERNATIONAL GmbH
Address: Flinger Broich 203, 40235 Duesseldorf, Germany
Product: Gasoline chainsaw "Könner & Söhnen"
Type / Model: KS CS21G, KS CS21G-13, KS CS21G-16, KS CS21G-16-1,
KS CS31G, KS CS31G-16, KS CS31G-18, KS CS31G-20
KS CS31G-16-1, KS CS31G-18-1, KS CS31G-20 -1

The statement is based on a single evaluation of above mentioned products. It does not imply an assessment of the whole production and does not permit the use of the test lab. logo. The manufacturer should ensure that all product in series production are in conformity with the product sample detailed in this report. The applicant should hold the whole technical report at disposal of the competent all the right.

Applied EC Directives: 2006/42/EC Machinery Directive
2000/14/EC Noise Directive
(EU) 2016/1628 Non-Road mobile machinery emissions

Applied Standards: EN ISO 11681-1:2022
EN ISO 12100:2010

Gasoline engine KS 80 corresponds to European Emission Standard Euro 5 (STAGE V). This is confirmed by EU TYPE-APPROVAL CERTIFICATE granted by NSAI certification of Dublin. Technical service responsible for carrying out the test - TUV.
Date of issue 17/01/2019

Gasoline engine KS 90 corresponds to European Emission Standard Euro 5 (STAGE V). This is confirmed by EU TYPE-APPROVAL CERTIFICATE issued by ministry of industry, trade and tourism of Madrid. Technical service responsible for carrying out the test - IDIADA.
Date of issue 07/05/2019

2000/14/EC_2005/88/EC Annex VI

For model KS CS21G Noise measured Lwa = 113,2 dB (A), guaranteed Lwa = 117 dB (A)
For model KS CS31G Noise measured Lwa = 111,9 dB (A), guaranteed Lwa = 117 dB (A)



23

Issued Date: 2024-06-24
Place of issue: Duesseldorf
Director: Fomin P.

P. Fomin

DIMAX

International GmbH
Flinger Broich 203 40235 Düsseldorf
USt-ID DE296177274
koenner-soehnen.com

We DIMAX INTERNATIONAL GmbH hereby declare that specified above conforms covering European Parliament and Council Directives, 2006/42/EC of 17 May 2006 Machinery Directive, Noise Directive 2000/14/EC of 8 May 2000. The CE mark above can be used under the responsibility of manufacturer. After completion of an EC declaration of Conformity and compliance with all relevant EC directives.

CONTACTS

Deutschland:

DIMAX International GmbH Flinger
Broich 203 -FortunaPark- 40235
Düsseldorf, Deutschland
www.konner-sohnen.com

Ihre Bestellungen

orders@dimaxgroup.de

Kundendienst, technische Fragen und Unterstützung

support@dimaxgroup.de

Garantie, Reparatur und Service

service@dimaxgroup.de

Sonstiges

info@dimaxgroup.de

Polska:

DIMAX International Poland Sp.z o.o.
ul. Południowa 8, 05-830,
Stara Wieś, Polska,
info.pl@dimaxgroup.de
www.konner-sohnen.com

Україна:

ТОВ «Генератор альянс»,
вул. Електротехнічна 47,
02225, м. Київ, Україна
sales@ks-power.com.ua
www.konner-sohnen.com