

Please, read this manual
carefully before use!

Owner's Manual



Lithium battery

KS LB 24-100

KS LB 48-100

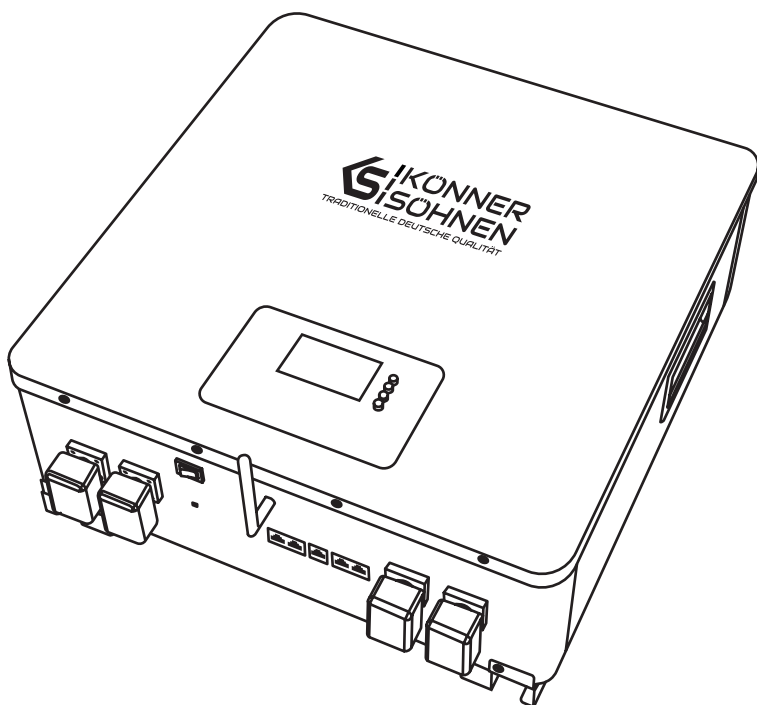



Thank you for opting for **Könnner & Söhnen®** products. This manual contains a brief description of safety, setup and use. More information can be found on the official importer's website in the support section: konner-sohnen.com/manuals. You can also go to the support section and download the manual by scanning the QR code or on the website of the official importer of **Könnner & Söhnen®** at www.konner-sohnen.com



Please, read this manual carefully before use!

The manufacturer of **Könnner & Söhnen®** products reserves the right to make changes that may not be reflected in this manual, namely:

- The manufacturer reserves the right to make changes in the product design, configuration and construction.
- The images and drawings in this manual are for reference only and may differ from the actual components and inscriptions on the products.

Contact information that you are free to use in case of any problems can be found at the end of this manual. All information in this manual is correct to the best of our knowledge and belief at the date of its publication. The current list of service centers can be found on the official importer's website at www.konner-sohnen.com



ATTENTION - DANGER!



Failure to follow the recommendations marked with this sign may lead to serious injury or death of the operator or third parties.



IMPORTANT!



Useful information while operating the machine.

WARNINGS AND SAFETY PRECAUTIONS

1

SAFETY PRECAUTIONS

- Before installing or using the battery, it is essential to read the user manual carefully. Failure to do so or to follow any instructions or warnings in this document may result in electric shock, serious injury or death, or may damage the battery, potentially rendering it inoperable.
- If the battery is stored for a long time, it must be charged every six months, and the SOC (state of charge) should be no less than 30%.
- The battery must be charged within 12 hours, after a total discharge.
- Do not install the product outdoors or beyond the operating temperature or humidity range listed in the manual.
- Do not expose the cable to the outside.
- Do not connect the power terminal reversely.
- All battery terminals must be disconnected before performing maintenance.
- Please contact the supplier within 24 hours if something abnormal occurs.
- Do not use detergent to clean the battery.
- Do not expose batteries to flammable or harsh chemicals or vapours.
- Do not paint any part of the battery, including internal or external components.
- Do not connect the battery with PV solar wiring directly.
- Do not insert any foreign objects into any part of the battery.



Li-ion



BEFORE CONNECTING THE BATTERY:

- After unpacking, please check the product and packing list. If the product is damaged or parts are missing, get in touch with your local dealer.

- b). Before installation, switch the grid power off and ensure the battery is in the turned off mode.
- c). Provide proper wiring: do not mix up the positive and negative cables, and ensure there are no short circuits with external devices.
- d). It is forbidden to connect the battery directly to AC power.
- e). The battery-embedded BMS (Battery Management system) is designed for single battery voltage. Please do not connect the battery in series.
- f). Please ensure that the electrical parameters of the battery system are compatible with related equipment.
- g). Keep the battery away from water and fire.

BEFORE USING THE BATTERY:

- a). If you need to move or repair the battery system, switch off the power supply and turn off the battery completely.
- b). It is forbidden to connect the battery with different types of batteries.
- c). Connecting the battery to a faulty or incompatible inverter is forbidden.
- d). It is forbidden to disassemble the battery (the QC label falls off or is damaged).
- e). Do not open, repair, or disassemble the battery except by qualified technicians from your seller or those whom he has authorized. We are not responsible for any consequences or liabilities resulting from violations of safety procedures or failure to follow design, production, and equipment safety standards.

INTRODUCTION 2

Switched Lithium Iron Phosphate Battery is a new energy storage product, which can provide reliable power supply for various equipment and systems.

Switched Lithium Iron phosphate battery has an integrated BMS (Battery Management system), which can manage and monitor battery voltage, current, temperature and other information.

HIGHLIGHTS

- High-cycle Life
- Longer Service Life
- Integrated Circuit Protection
- Low Discharge Rate
- Quick Recharge
- Supports Parallel Operation

MAIN OVERVIEW 3

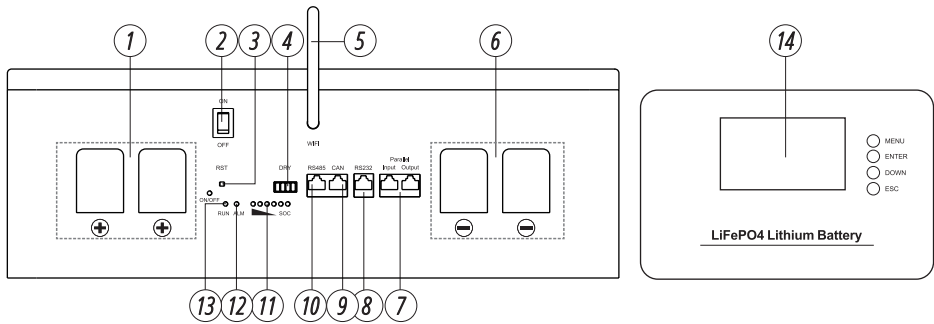

- | | | |
|------------------------|-----------------------------|-------------------|
| 1. BAT + | 6. BAT - | 11. SOC Indicator |
| 2. Power switch | 7. Parallel connection port | 12. ALM Indicator |
| 3. RST | 8. RS232 interface | 13. RUN Indicator |
| 4. PF control contacts | 9. CAN bus | 14. LCD screen |
| 5. Wi-Fi antenna | 10. RS485 interface | |

SHORT DESCRIPTION OF IDENTIFYING PARTS (DETAILED DESCRIPTION FOUND IN SETTINGS AND DESCRIPTIONS)

1. BAT +: Battery positive terminal.
2. Main switch.
3. RST: When the BMS is inactive, press the button (3–6 seconds) and release it. The protection board will be activated, and the LED indicator will light up for 0.5 seconds from "RUN".
When the BMS is active, press the button (3–6 seconds) and release it. The protection board will be deactivated, and the LED indicator will light up for 0.5 seconds from the lowest power indicator.
- When the BMS is active, press the button (6–10 seconds) and release it. The protection board will be reset, and all LED lights will illuminate for 1.5 seconds.
4. PF control contacts.
5. Wi-Fi antenna.
6. BAT -: Battery negative terminal.
7. Parallel connection port.
8. RS232 interface: RS-232 connection to the computer, enabling the manufacturer or a professional technician to perform the configuration service.
9. CAN bus interface.
10. RS485 interface.
11. SOC Indicator: Six green LEDs indicate the current state of charge of the battery.
12. Alarm Indicator: Red LED blinks when the battery triggers an alarm.
13. RUN Indicator: Green LED indicates the operating status of the battery.
14. LCD screen: Displays battery parameters and status information.

**IMPORTANT!**

Manufacturer reserves the right to make changes and/or improvements in design, components set and technical attributes without notice and without incurring obligation. The pictures in this manual are schematical and may not match the parameters of original product.

PACKAGE INCLUDES

- Lithium Iron Phosphate Battery
- Single Battery Pack:
 - 2 × Communication cable
 - 4 × Open Terminal
 - 1 × Installation Mounting Rack and Expansion
- Instruction Manual

TOOLS REQUIRED FOR INSTALLATION

Tools that are required for installation (Tools and consumables are not provided);

- Wire cutters
- Crimping modular pliers
- Screwdriver

Model	KS LB 24-100	KS LB 48-100
Nominal voltage	25,6V	51,2V
Discharge voltage	21,6 – 29,2V	43,2 – 58,4V
Charging voltage	29,2V	58,4V
Recommended charging	50A (0,5C)	
Max charging current	100A (1C)	
Recommended discharging current	50A (0,5C)	
Max discharging current	100A (1C)	
Communication	RS485/RS232/CAN	
Depth of Discharge	95%	
Working temperature	0 °C to 45 °C Charge	
	-10 °C to 45 °C Discharge	
Shelf temperature	0 °C to 35 °C	
IP degree	IP21	
Humidity	5 to 95% (RH)	
Elevation	< 4000 m	
Dimensions (LxWxH)	557×547×227 mm	700×569×327 mm
Net weight	27 kg	45 kg

SETTINGS AND DESCRIPTIONS

5

BMS COMMUNICATION PROTOCOL SETTINGS

Fig. 1

In the “Para Setting” section, the display screen has the function of setting the BMS protocol.

Users can view and select the required communication protocol through buttons,

and send the selected protocol version number back to the BMS motherboard program, thereby changing the communication protocol between the BMS and inverter.

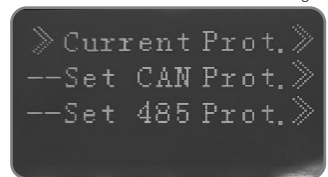
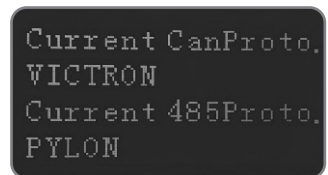

Fig. 2

- 1). In the main menu, use the down arrow key to move the cursor “>>” to the “Para Setting” column. Press the Enter key to enter the submenu (fig.1). Select “Current Prot” to set the communication protocols for CAN bus and RS-485 and RS-232 interfaces. Press the Enter key to view the current default communication protocol settings, as shown in Figure 2.



- 2). Set CAN communication protocol

Select “Set CAN Prot” and press the Enter key to open the parameters as shown in Figure 3. Move the cursor “>>” to the appropriate column of the desired protocol name and press the Enter key to open the protocol settings, as shown in Figure 4. Select “PYLON” to set the communication protocol, and press the Enter key to choose “YES” and save the setting parameter, as shown in Figure 5. Press the ESC key to return to the previous interface.

Fig. 3

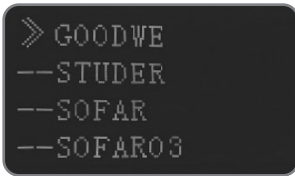

Fig. 4

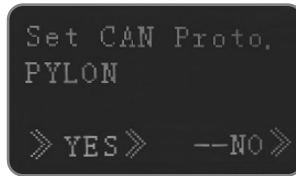

Fig. 5



3). Set RS-485 communication protocol

In the interface, as shown in Figure 1, use the down arrow key to select the "Set 485 Prot" column and press the Enter key to set the corresponding RS-485 communication protocol. The steps are the same as those for setting the CAN communication protocol.



1 2 3 4

DRY CONTACT OUTPUT DESCRIPTION:

1. Dry contact 1 -PIN 1 to PIN 2: normally open, low battery closed.
2. Dry contact 2-PIN3 to PIN 4: normally open, closed during fault protection.

RS485 AND CAN: FOR AN INVERTER AND A SECONDARY BATTERY:

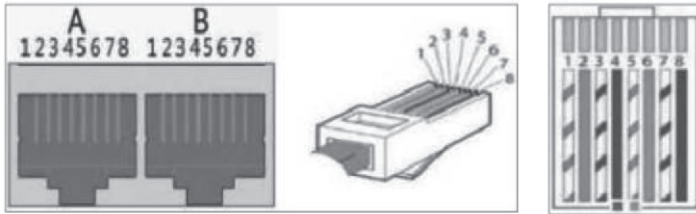

Communication port Definition:

Port	Definition	
RS485 Communication Port Definition	PIN 1	RS485-B
	PIN 2	RS485-A
	PIN 3	GND
	PIN 4	NC (Empty)
	PIN 5	NC (Empty)
	PIN 6	GND
	PIN 7	RS485-A
	PIN 8	RS485-B

Port	Definition	
CAN Communication port Definition	PIN 1	NC (Empty)
	PIN 2	GND
	PIN 3	NC (Empty)
	PIN 4	CANH
	PIN 5	CANL
	PIN 6	NC (Empty)
	PIN 7	NC (Empty)
	PIN 8	NC (Empty)

BATTERY PACK PARALLEL FUNCTION:

a). Use a parallel communication cable to connect the parallel output interface of the host machine to the interface of the first slave machine, and then connect the parallel output interface of the first slave machine to the parallel input interface of the second slave machine. Connect in sequence according to the above method.

b). When parallel status, only the primary battery pack communicate with the PC upper computer as remote monitoring, uploading data, displaying status and any other info of all battery packs.

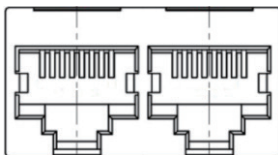

Parallel port

Parallel Output RJ45		Parallel Input RJ45	
Pin	Clarifying	Pin	Clarifying
1, 8	RS485-B	9, 16	RS485-B
2, 7	RS485-A	10, 15	RS485-A
3, 6	GND	11, 14	GND
4	GND	13	UP_IN
5	DN_OP+	12	GND

RS232 (ADJUSTING)

RS232 connecting with upper computer to let manufacturer or professional engineer to process adjusting service.

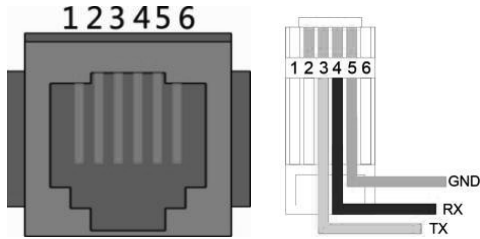

RS232 Port

Port	Clarifying	
RS232 Communication port Definition	PIN 1	NC (Empty)
	PIN 2	NC (Empty)
	PIN 3	TX: BMS sends data (PC receives data)
	PIN 4	RX: BMS receives data (PC sends data)
	PIN 5	GND
	PIN 6	NC (Empty)

LED SIGNAL LIGHTS

Condition	RUN	ALR	1	2	3	4	5	6
OFF	–	–	–	–	–	–	–	–
ON	green	red	green	green	green	green	green	green
NORMAL	green	–	–	–	–	–	–	–
CHARGE	green	–	show soc					
DISCHARGE	green	–	show soc					
Alarm	ALM "Red" Other LEDs are same as above.							
System fault or protection	–	red	–	–	–	–	–	–
Green/Red	ON							
Green	flash, on: 0.3s; off: 3.7s							
Green/Red	flash, on: 0.5s; off: 1.5s							

BMS BASIC FUNCTION

Management and monitor

- Cells Balance
- Intelligent Charge Model
- Charge/Discharge Current Limit
- Capacity Retention Calculate
- Administrator Monitor
- Operation Record
- Power Cable Reverse
- Soft start of inverter

Protection and alarm

- Charge/Discharge End
- Charge Over Voltage
- Discharge Under Voltage
- Charge/Discharge Over Current
- High/Low Temperature(cell/BMS)
- Short Circuit

SAFE HANDLING GUIDE OF LITHIUM BATTERIES

6

SCHEMATIC DIAGRAM OF SOLUTION

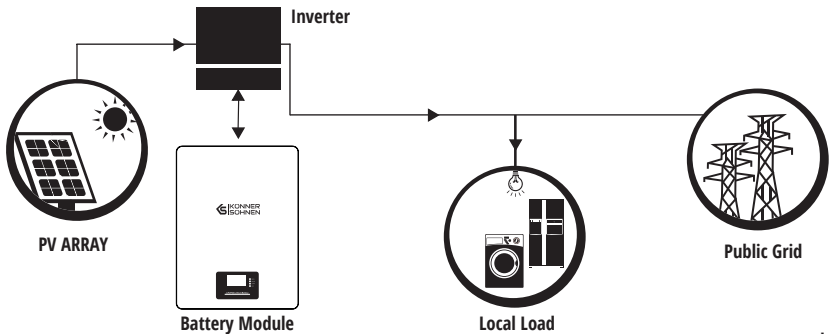

**ATTENTION - DANGER!****DANGER LOW DC VOLTAGE INSIDE
DANGER ARC FLASH & SHOCK HAZARD**

- Do not disconnect or disassemble by non-professional personnel.
- Do not drop, deform, impact, cut, or pierce with a sharp object.
- Do not place at a children or pet touchable area.
- Do not place near open flame or flammable material.
- Do not cover or wrap the product case.
- Do not sit or put heavy things on battery.
- Do not touch any liquid that is leaking.
- Avoid direct sunlight.
- Avoid of moisture or liquid.
- The product Ingress Protection (IP) class is IP20.
- Make sure the grounding connection set correctly before operation.
- Follow the product manual to make wiring connection.
- If leaking, fire, wet or damaged, switch off the breaker on DC side and stay away from battery.
- Contact your supplier within 24 hours if anything failure happens.

TOOLS

1. Wire cutter
2. Crimping modular pliers
3. Screwdriver

①



②



③

**NOTE**

Use appropriately insulated tools to prevent accidental electric shock or short circuits. If insulated tools are unavailable, cover the entire exposed metal surfaces of the available tools, except their tips, with electrical tape.

SAFETY GEAR

It is recommended to wear safety gear, insulated gloves, safety Goggles and safety shoes when dealing with the battery pack.

1. Insulated gloves
2. Safety goggles
3. Safety shoes

①



②



③

**INSTRUCTIONS FOR USE****7****PACKAGE ITEMS:**

Unpack and check the packing list.

1. Battery Module Package

- a). Single Battery Pack:
 - 2 × Communication cable
 - 4 × Open Terminal
 - 1 × Installation Mounting Rack and Expansion Screws
 - 1 × Instruction Manual

b). can be customized per requirement:

- 1 × Battery cable
- 1 × Communication cable
- 1 × Parallel cable



2. For Battery system connecting to inverters:

- 2 × Long power cables
- 1 × Communication cable for each energy storage system



INSTALLATION LOCATION

Make sure that the installation location meets the following conditions:

1. The area is completely waterproof.
2. The floor is flat and level.
3. There are no flammable or explosive materials.
4. The ambient temperature ranges from 0 °C to 45 °C.
5. The temperature and humidity are maintained at a constant level.
6. There is minimal dust and dirt in the area.
7. The distance from the heat source is more than 2 meters.
8. The distance from the air outlet of the inverter is more than 0.5 meters.
9. The installation area should avoid direct sunlight.
10. The battery module has no mandatory ventilation requirement, but please avoid installation in confined areas. The operation shall avoid high salinity, humidity, or temperature.

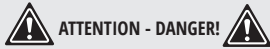

If the ambient temperature is outside the operating range, the battery module will stop functioning to protect itself. The optimal temperature range for the battery module is between 15 °C and 35 °C. Frequent exposure to extreme temperatures can impair the performance and lifespan of the battery module.

INSTALLATION OF MOUNTING RACK

Install the battery mounting rack with following drawing dimension.

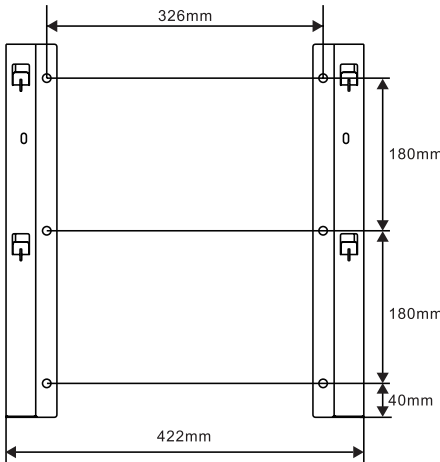

The dimensional drawing of universal rack for other models

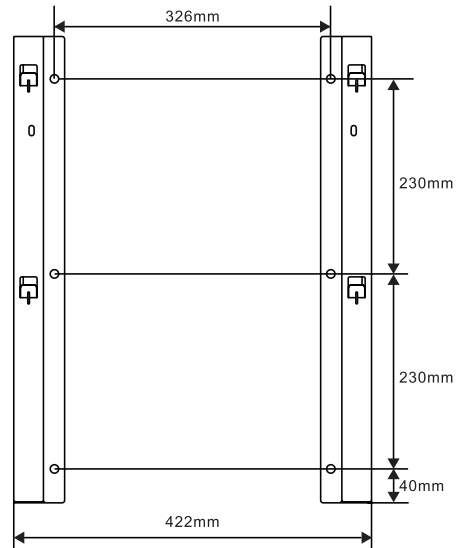

The dimensional drawing of dedicated rack for KS LB 48-100

INSTALLATION OF BATTERY PACK

1. Connect the cables between battery modules.
2. Connect the cables to the inverter.



1. A suitable breaker between the battery system and inverter is required.
2. The complete installation and operation of the system must follow the local electric standard.

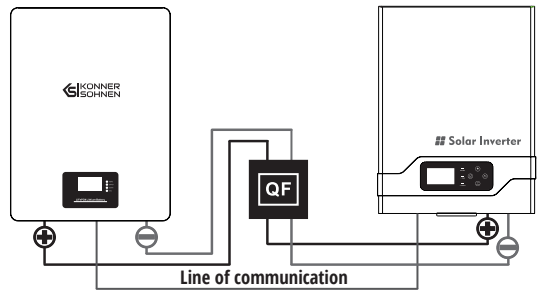

POWER ON:

Double check all the power and communication cables.

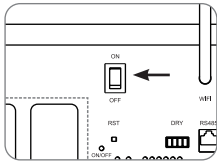

1. Switch on all the battery modules.
2. The one with an empty "Linkport 1" is the primary battery module; the others are secondary (1) primary Battery configuration with a maximum of 15 secondary batteries;
3. Switch the red switch on the primary battery to turn the power on; all the battery LEDs will be on one by one from the primary battery.

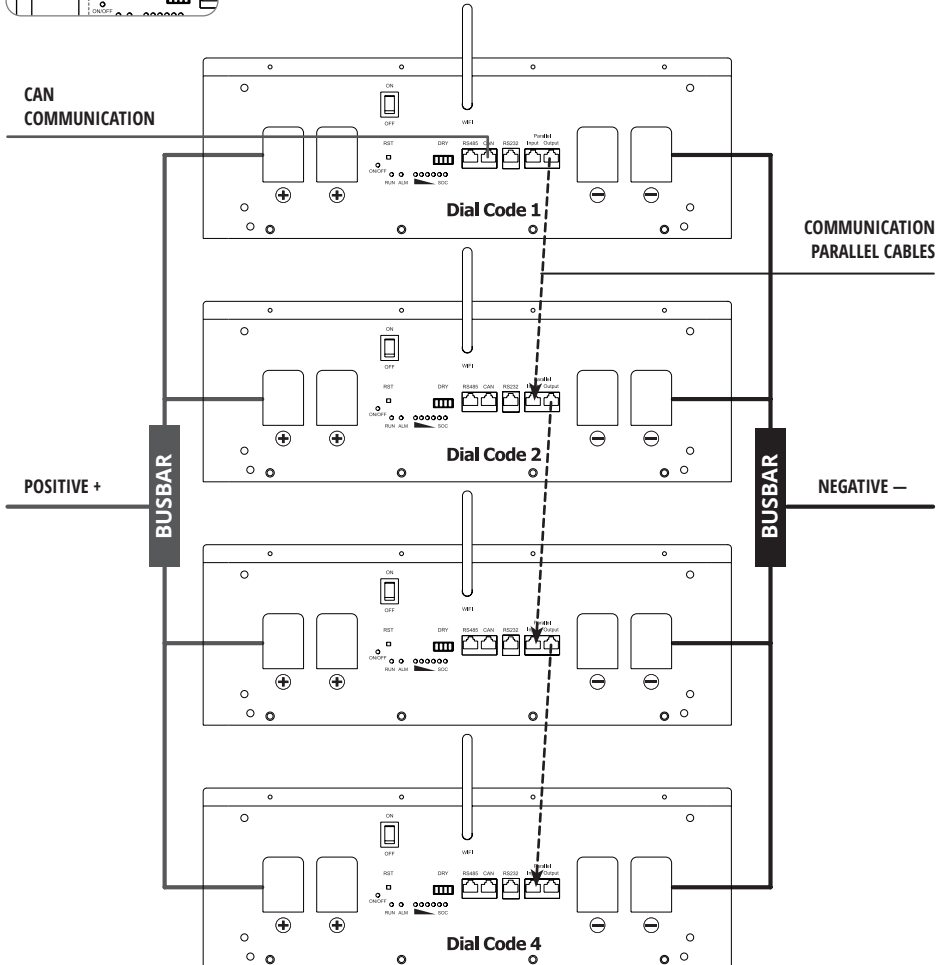



NOTE



- After the battery module is powered on, the soft start function will activate, which takes 3 seconds. After the soft start, the battery is ready for high-power output.
- During capacity expansion or replacement, when different parallel soc/voltage of a module are together, please maintain the system idle for ≥ 15 mins or until the SOC LED lights up (≈ 1 LEDS difference) before regular operation.

POWER OFF

1. Turn the external power source off.
2. Activate the switch on the master battery; all batteries will be turned off.
3. Turn off the power switch.

MULTI-GROUP MODE

Connect the power cable first:

1. Each pair of cables supports a max of 100A constant current. Connect an appropriate number of cable pairs based on the system current calculation.
2. A suitable protection breaker between the battery system and inverter is required.
3. Make sure all DIP switches of the primary batteries are ROxX, then turn the batteries on.
"R": is the baud rate of RS485, which must be the same for all primary batteries.
4. After all the batteries are running, the primary battery alarm in group will sound 3 times. This indicates that all the groups are online.

EMERGENCY SITUATIONS

8

LEAKING BATTERIES

If the battery pack leaks electrolyte, avoid contact with the leaking liquid or gas. If exposed to the leaked substance, immediately perform the following actions:

- a. Inhalation: Evacuate the contaminated area and seek medical attention.
- b. Contact with eyes: Rinse eyes with flowing water for 15 minutes and seek medical attention.
- c. Contact with skin: Wash the affected area thoroughly with soap and water and seek medical attention.
- d. Ingestion: Induce vomiting and seek medical attention.

WET BATTERIES

If the battery pack is wet or submerged in water, keep people from accessing it, and then contact an authorized dealer for technical support. Cut off all power switches on the inverter.

DAMAGED BATTERIES

Damaged batteries are dangerous and must be handled with the utmost care. They should not be used. And may pose a danger to people or property. If the battery pack appears damaged, pack it in its original container and return it to an authorized dealer.



ATTENTION - DANGER!



Damaged batteries may leak electrolytes or produce flammable gases.

BATTERY MAINTENANCE

9

Maintenance while in use and storage:

1. Charging the battery at least once every 6 months is required. For the maintenance charge, ensure the SOC is higher than 30%.
2. Every year after installation, check the connections of power connectors, grounding points, power cables, and screws. Ensure there are no loose, broken, or corrosion at connection points. Check the installation environment, such as dust, water, insects etc.
3. If the battery is stored for a long time, it should be charged every six months, and the SOC should be higher than 30%.

CLEANING INSTRUCTIONS - GENERAL

10

- Before cleaning: Ensure the product is not hot and has nothing connected to it before cleaning or maintaining it.
- Cleaning: wipe down the product surface using a soft, dry cloth.
- Do not use harsh or abrasive cleaning chemicals or materials on the product, as doing so may damage or scratch the finish.
- Do not expose the product to direct sunlight or high temperatures for extended period.
- Do not store in temperatures over 45 °C.

ENVIRONMENTALLY FRIENDLY DISPOSAL

11

IMPORTANT INFORMATION FOR CORRECT DISPOSAL OF ELECTRICAL AND MECHANICAL COMPONENTS

At the end of its working life, the product must not be disposed of as urban waste. It must be taken to a local authority's designated waste collection center or a dealer that provides this service. Disposing a household appliance separately helps avoid negative environmental and health consequences from inappropriate disposal. It enables the constituent materials to be recovered to obtain significant savings in energy and resources. As a reminder of the need to dispose of household appliances separately, the product is marked with a crossed-out wheeled dustbin.

- Never dispose of used electrical and mechanical components with ordinary solid waste since they contain toxic substances.
- Always dispose of used electrical and mechanical components following the prevailing community regulations that apply to the disposal of electrical and mechanical components.



EC Declaration of Conformity

Nr. 201

The following products have been tested by us with the listed standards and found in compliance with the European Community Electromagnetic compatibility Directive (EMC) 2014/30/EC.

Manufacturer: DIMAX INTERNATIONAL GmbH
Address: Flinger Broich 203, 40235 Duesseldorf, Germany
Product: Lithium battery "Könner & Söhnen"
Type / Model: KS LB 24-100, KS LB 48-100

The statement is based on a single evaluation of above mentioned products. It does not imply an assessment of the whole production and does not permit the use of the test lab. logo. The manufacturer should ensure that all product in series production are in conformity with the product sample detailed in this report. The applicant should hold the whole technical report at disposal of the competent all the right.

Applied EC Directives: 2014/30/EC Electromagnetic compatibility Directive (EMC)
Directive 2011/65/EU (RoHS) as last amended by
Directive (EU) 2015/863

Applied Standards: EN IEC 61000-6-3:2021
EN IEC 61000-6-1:2019
EN IEC 61000-3-2:2019
EN 61000-3-3:2013+A2:2021+AC:2022
EN 61000-3-3:2013+A1:2019
EN 61000-6-3:2007+A1:2011+AC:2012
EN IEC 61000-3-2:2019+A1:2021
IEC 62619:2022
IEC 62321-3-1:2013
IEC 62321-5:2013
IEC62321-4:2013+AMD1:2017
IEC 62321-7-2:2017
IEC 62321-7-1:2015
IEC 62321-6:2015
IEC 62321-8:2017



Issued Date:
Place of issue:
Director:

2024-07-25

Duesseldorf

Fomin P. *P. Fomin*

DIMAX

International GmbH
Flinger Broich 203 40235 Düsseldorf
USt-ID DE296177274
koenner-soehnen.com

We DIMAX INTERNATIONAL GmbH hereby declare that specified above conforms covering European Parliament and Council Directives, Electromagnetic compatibility Directive (EMC) 2014/30/EC of 26 February 2014. The CE mark above can be used under the responsibility of manufacturer. After completion of an EC declaration of Conformity and compliance with all relevant EC directives.

CONTACTS

Deutschland:

DIMAX International GmbH Flinger
Broich 203 -FortunaPark- 40235
Düsseldorf, Deutschland
www.konner-sohnen.com

Ihre Bestellungen

orders@dimaxgroup.de

Kundendienst, technische Fragen und Unterstützung

support@dimaxgroup.de

Garantie, Reparatur und Service

service@dimaxgroup.de

Sonstiges

info@dimaxgroup.de

Polska:

DIMAX International Poland Sp.z o.o.
Południowa 8, 05-830,
Stara Wieś, Polska,
info.pl@dimaxgroup.de
www.konner-sohnen.com

Україна:

ТОВ «Генератор Альянс»,
вул. Електротехнічна 47,
02225, м. Київ, Україна
sales@ks-power.com.ua
www.konner-sohnen.com